



FEM 解析入門

FEA NXで学ぶ 基礎操作からモデリング・解析まで

株式会社マイダスアイティジャパン 建設技術部



MIDAS

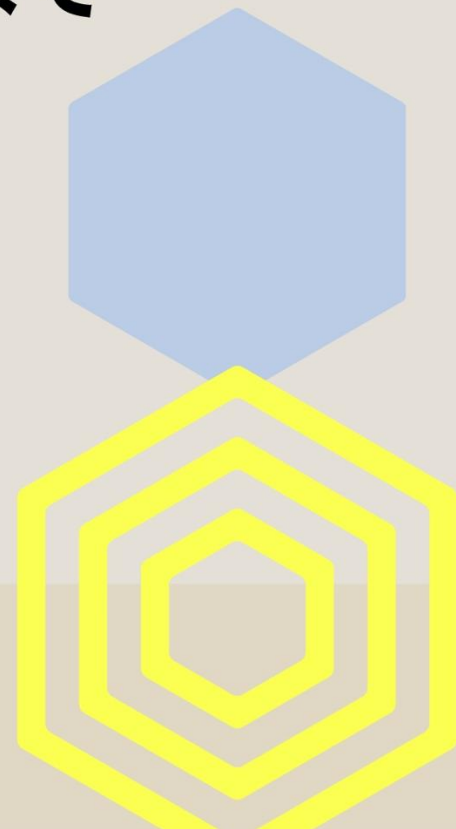

AGENDA



- SESSION 1 FEA NX 初心者操作ガイド
- SESSION 2 ジオメトリモデリング
- SESSION 3 2D解析
- SESSION 4 3D解析

MIDAS 工学分野製品製品紹介



MIDAS Family Programs

MIDAS Family Program は
最先端 CAE(Computer Aided Engineering) ソリューションです。



建築

Building Engineering

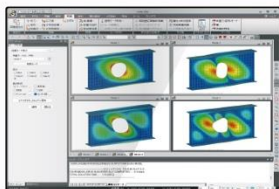

MIDAS iGEN

建築分野の
汎用構造解析および 許容応力度計算

MIDAS eGEN

保有耐力自動計算+構造計画/
設計最適化システム
CAD 基盤モデリング

MIDAS Drawing

世界初2次元情報CADプログラム
構造図自動生成



土木

Bridge Engineering

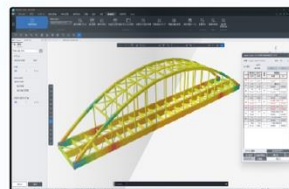

MIDAS CIVIL NX

土木分野の
汎用構造解析および 最適設計システム



地盤

Geotechnical Engineering

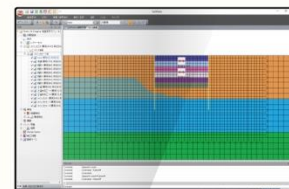

SOILWORKS

2次元地盤汎用解析/設計プログラム

SOILWORKS for FLIP

液状化解析プログラム FLIP用のプリ・ポスト

SOILWORKS for LIQCA

液状化解析プログラム LIQCA用のプリ・ポスト



機械

Mechanical Engineering

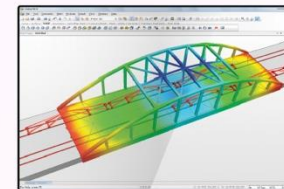

MIDAS NFX

機械分野の
汎用構造解析システム

FEA NX

2次・3次元構造・地盤汎用有限要素法解析ソリューション
線形から地盤非線形、構造非線形(鋼材、コンクリート)まで対応

FEA NXで学ぶ
初心者向けFEM解析体験セミナー

MIDAS

SESSION



FEA NX 初心者操作ガイド

- UI構成
- 基本操作

操作-モデルツリー

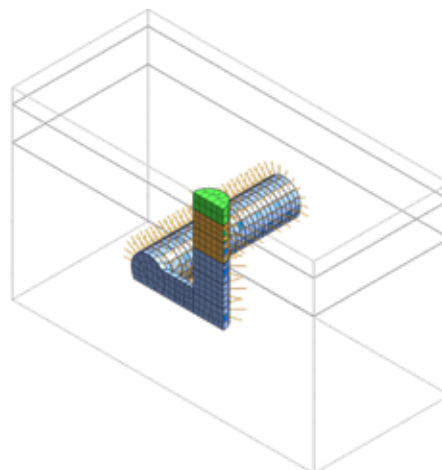
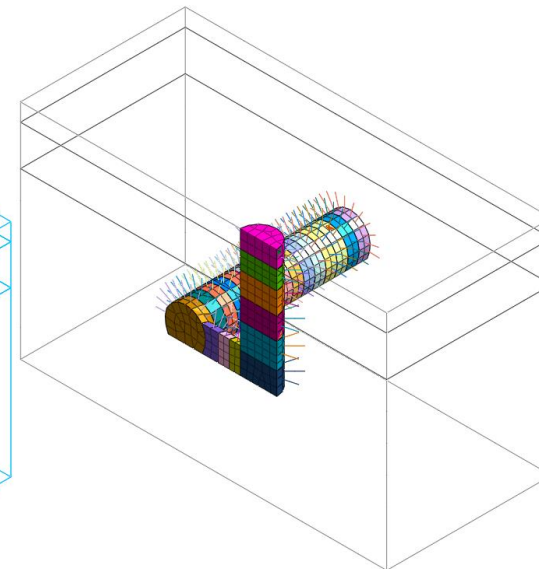
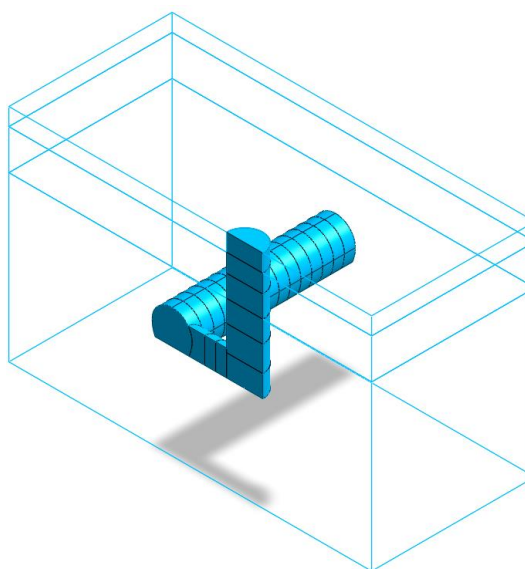
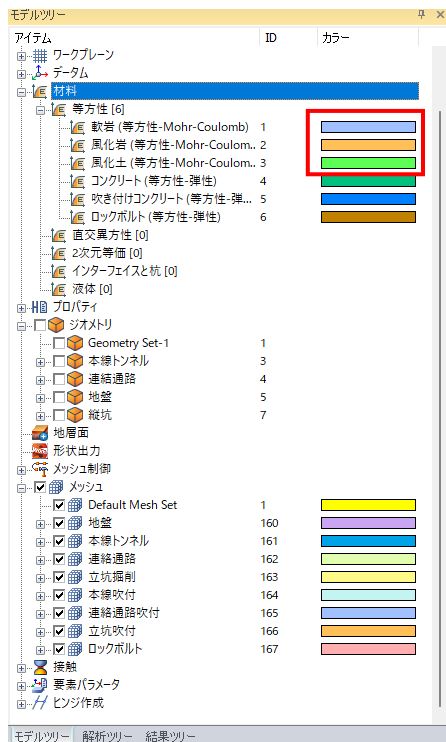

操作-解析ツリー

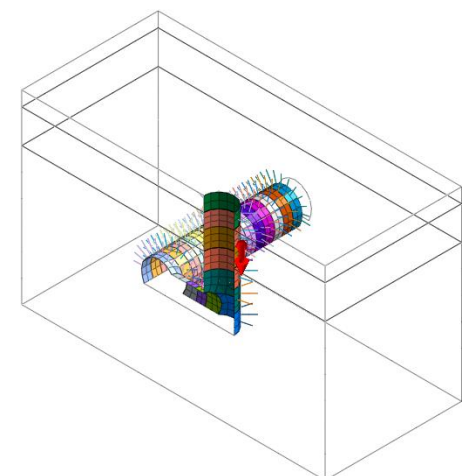
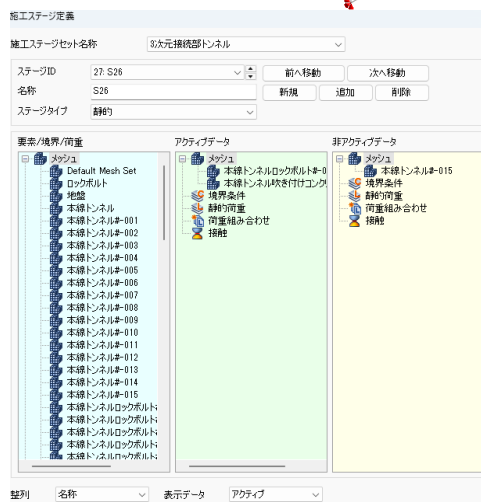
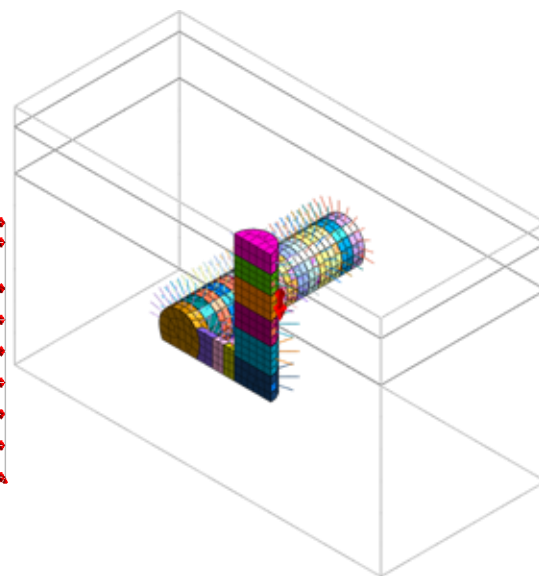
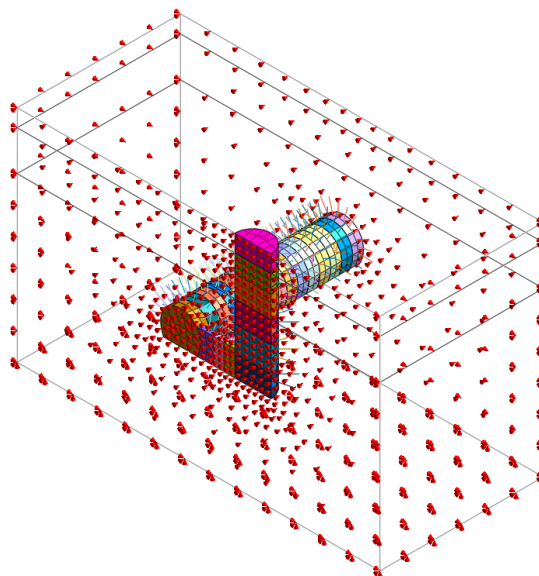
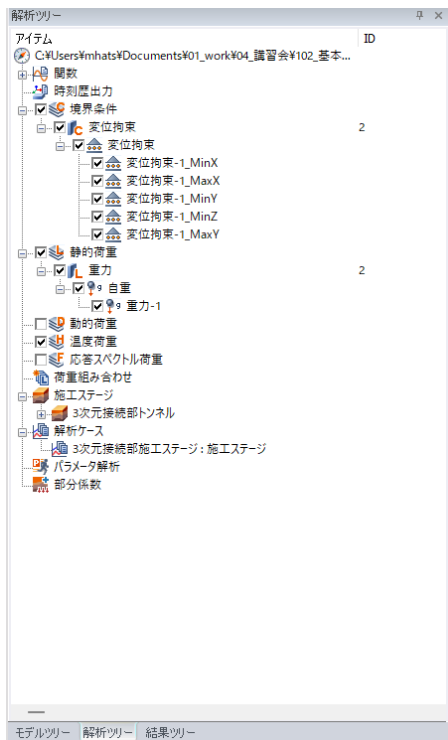

操作-結果ツリー

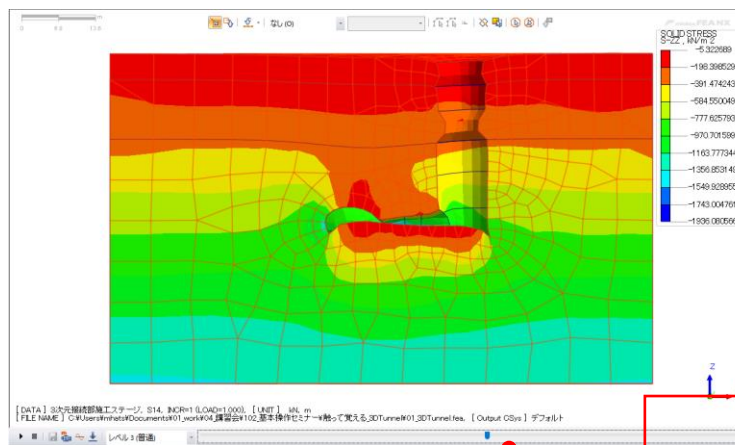
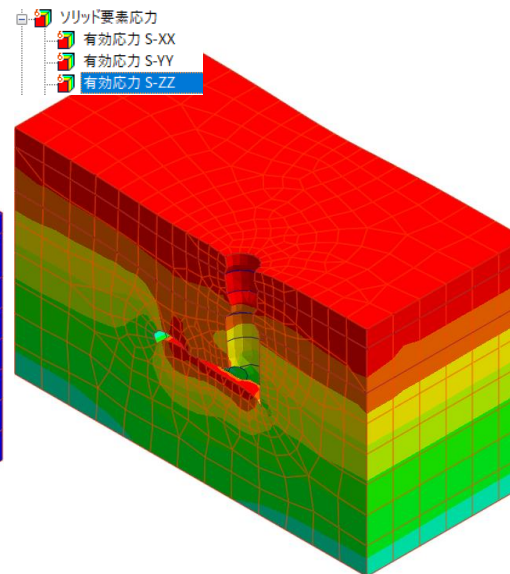
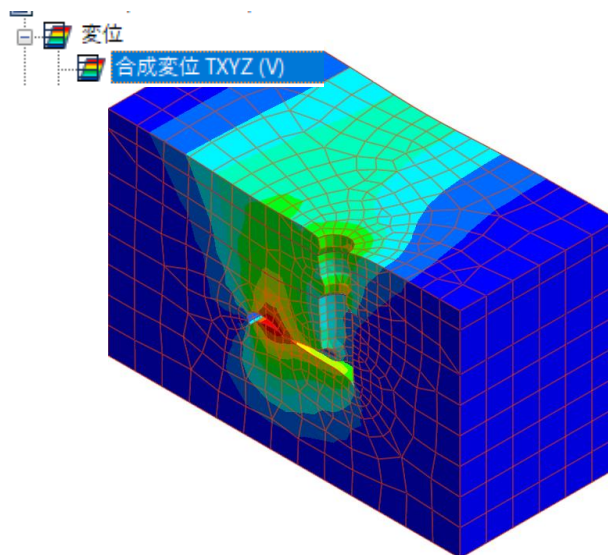
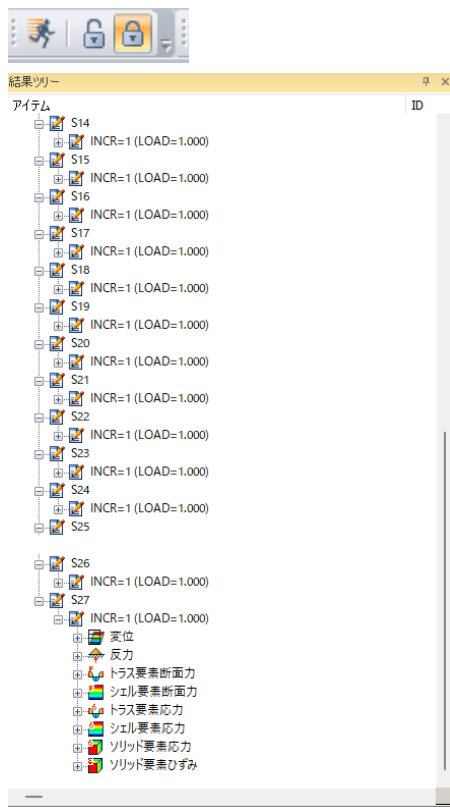

シークバー

FEA NXで学ぶ
初心者向けFEM解析体験セミナー

MIDAS

SESSION

2

ジオメトリモデリング

- 2Dジオメトリ操作
- 3Dジオメトリ操作

エッジ

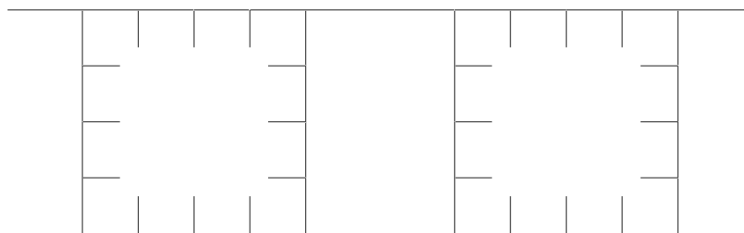

フェイス

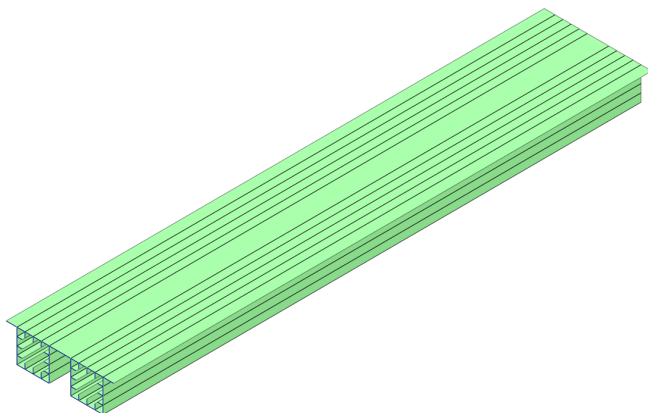

メッシュ

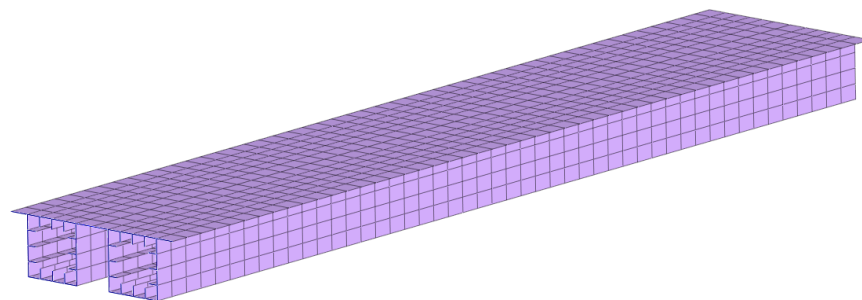

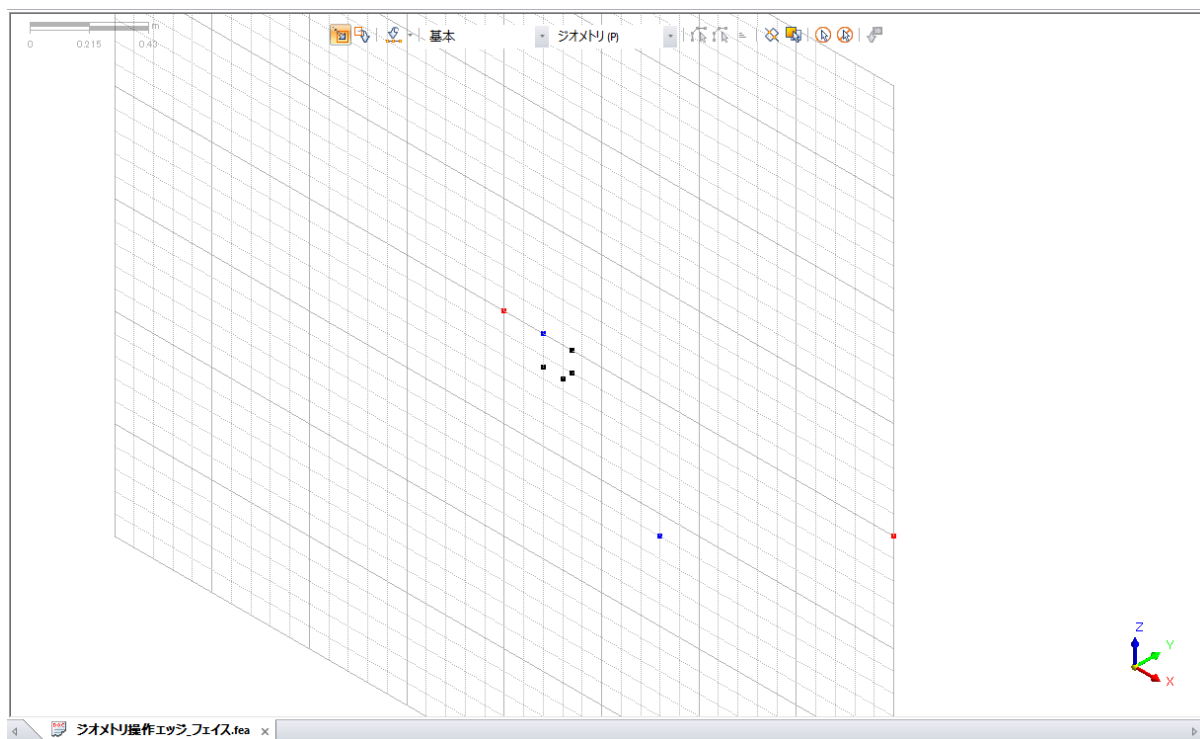
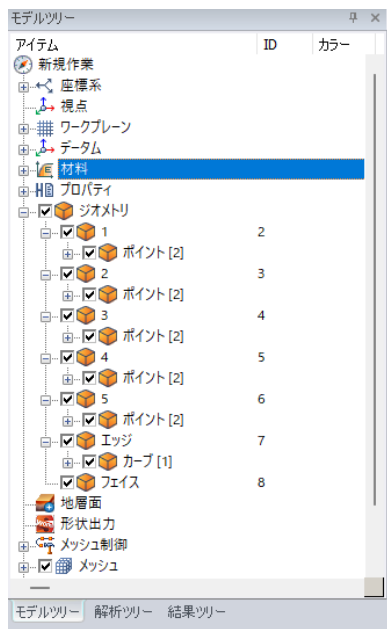

ワークプレーン : XZ > グリッド設定

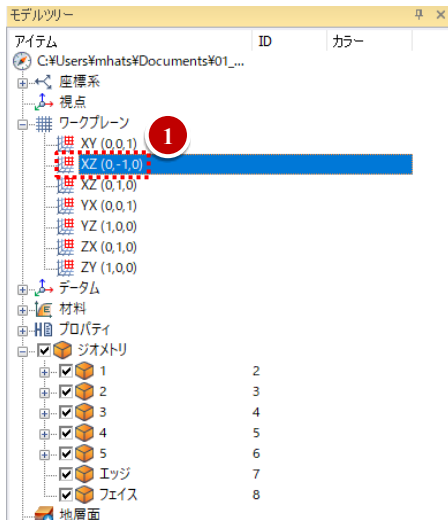

ワークプレーンは2Dジオメトリを作成する空間です。
ジオメトリ作成のダイアログで2Dタグの場合必ずワーク
プレーン上に作成されます。

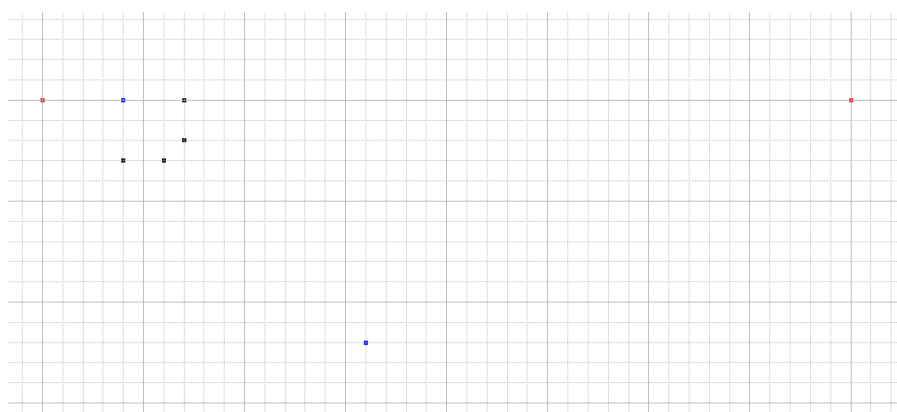
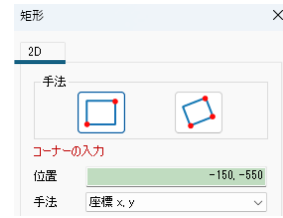

ライン作成 > 矩形作成

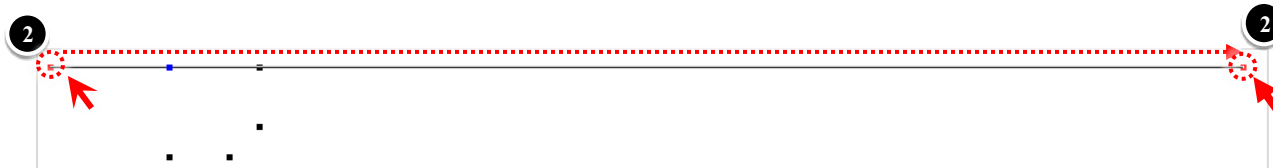

3

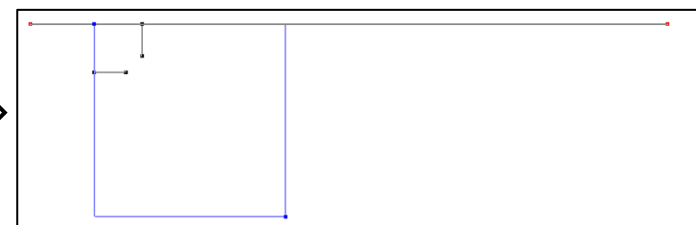
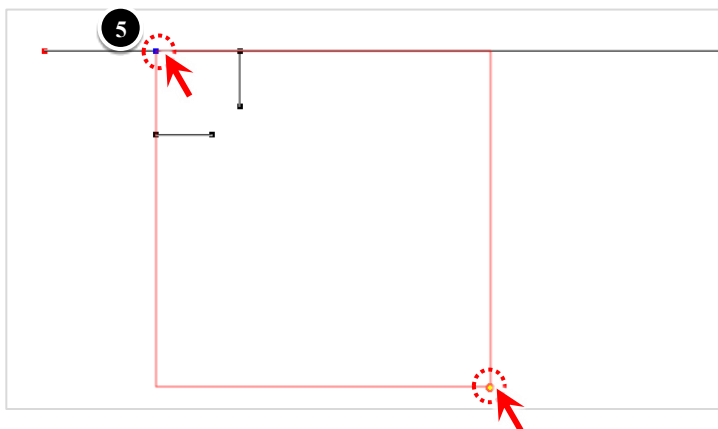

ジオメトリ並進 : コピー

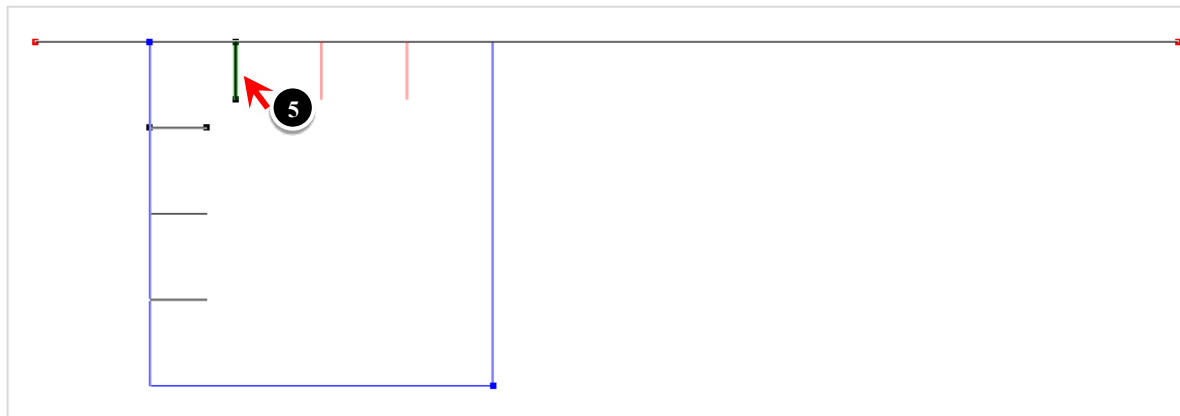
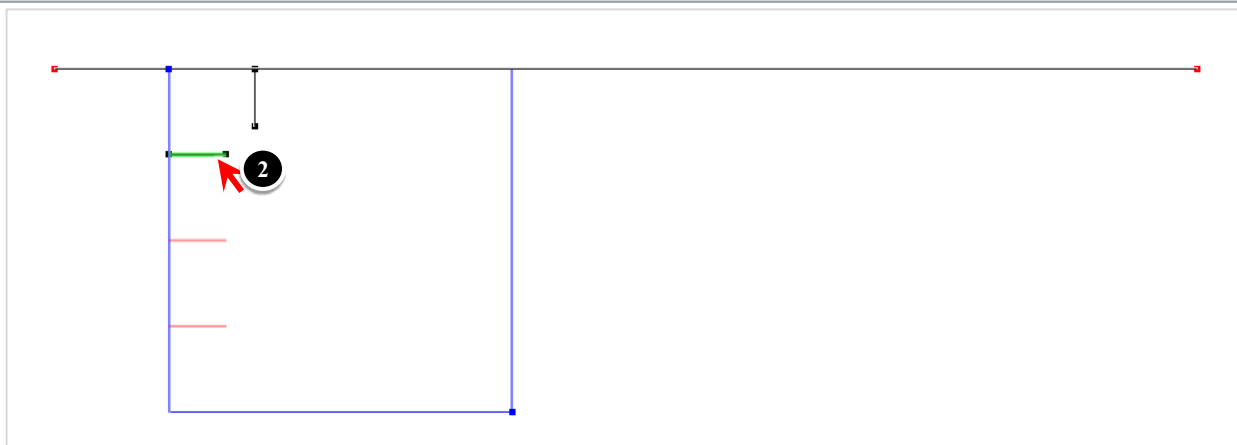
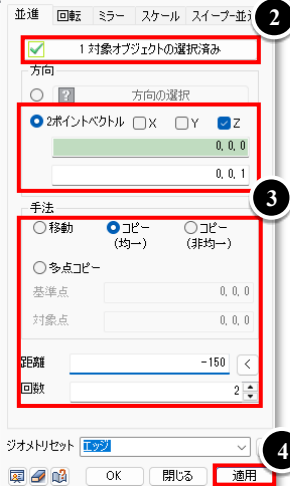

ジオメトリ並進 : コピー

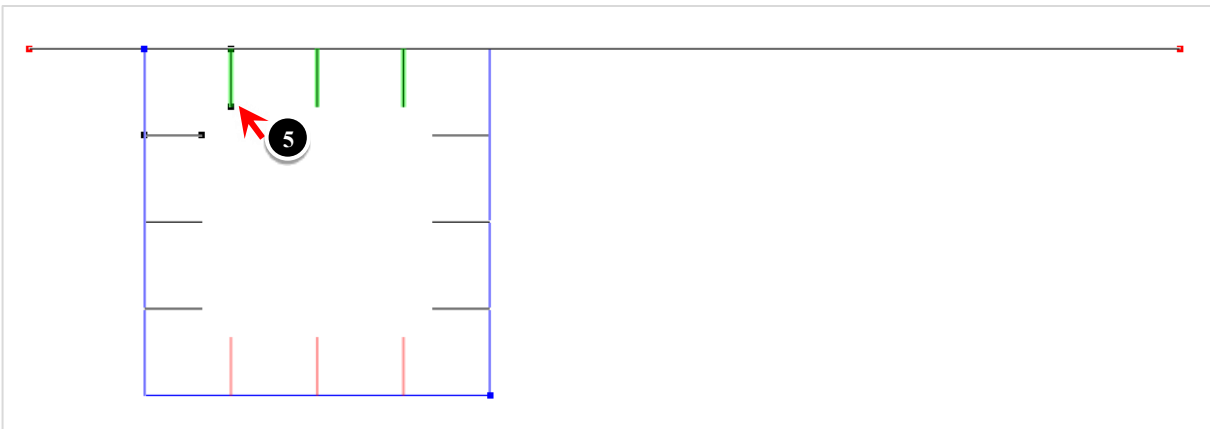
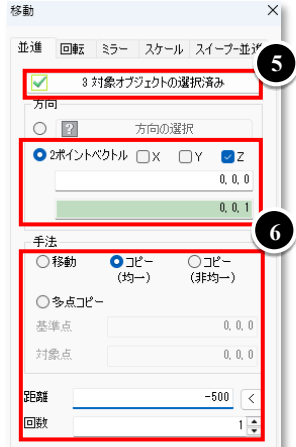
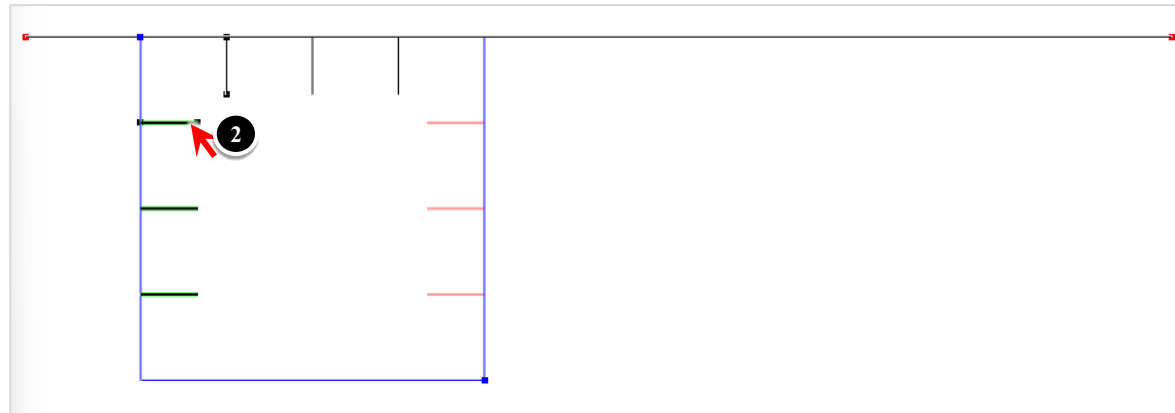

The screenshot displays the FEA NX software interface. The top toolbar contains various tools, with the '並進' (Move) tool highlighted by a red box and a circled '1'. Below the toolbar, the '移動' (Move) dialog box is open, showing the '並進' (Move) tab. The dialog box is annotated with red boxes and numbers 2, 3, and 4. Box 2 highlights the '19 対象オブジェクトの選択済み' (19 Selected Objects) field. Box 3 highlights the '手法' (Method) section, where 'コピー (均一)' (Copy (Uniform)) is selected. Box 4 highlights the '適用' (Apply) button. The 3D model shows a frame structure with green lines and a red dashed box around it, indicating the selected object. The copied structure is shown in red. The '距離' (Distance) is set to 1000 and '回数' (Count) is set to 1.

ジオメトリ交差

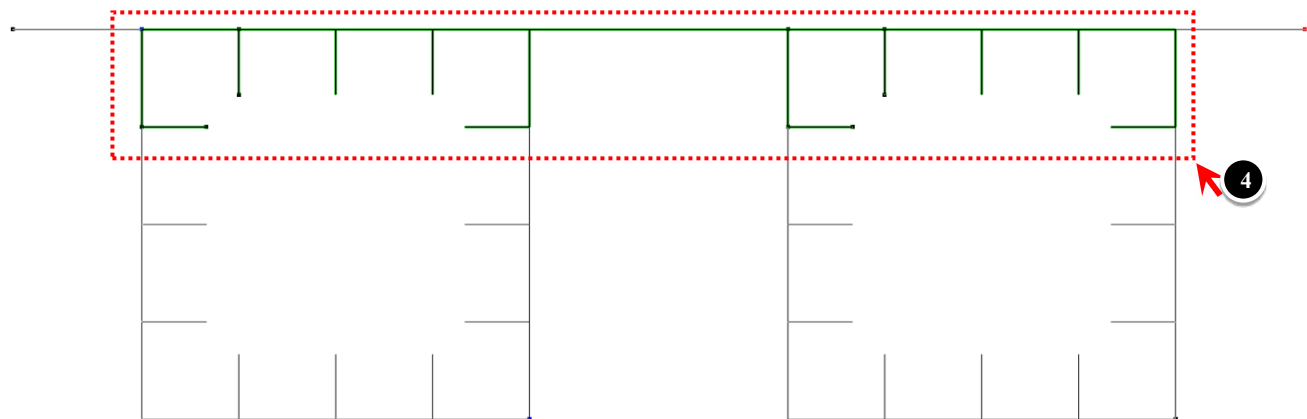
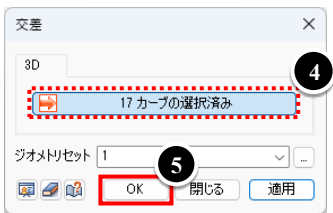
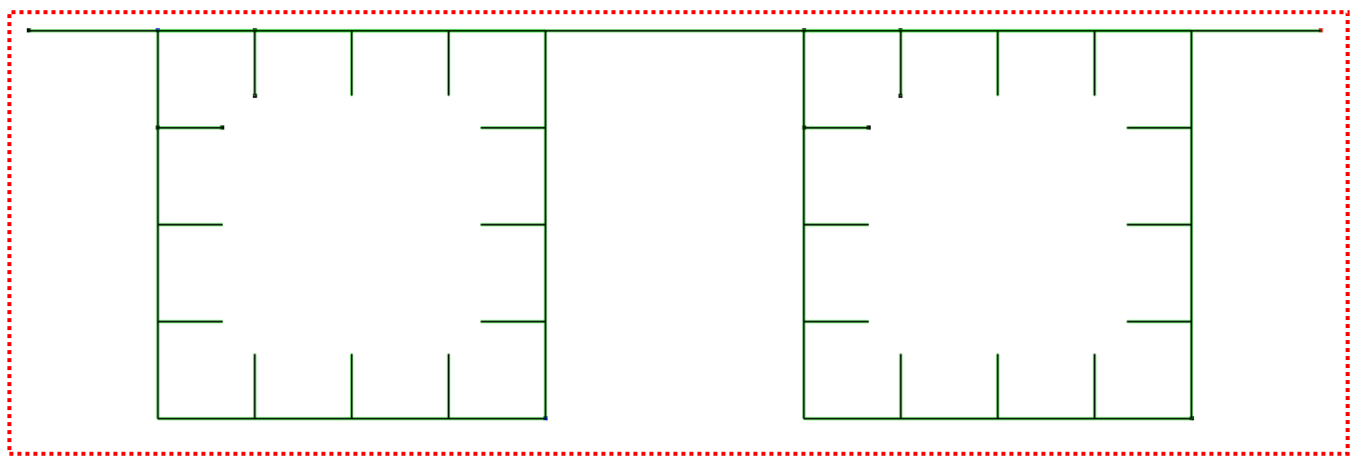
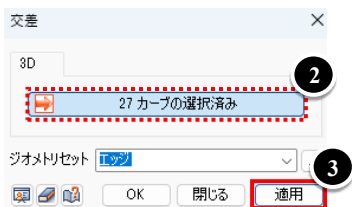

押し出し>フェイス作成

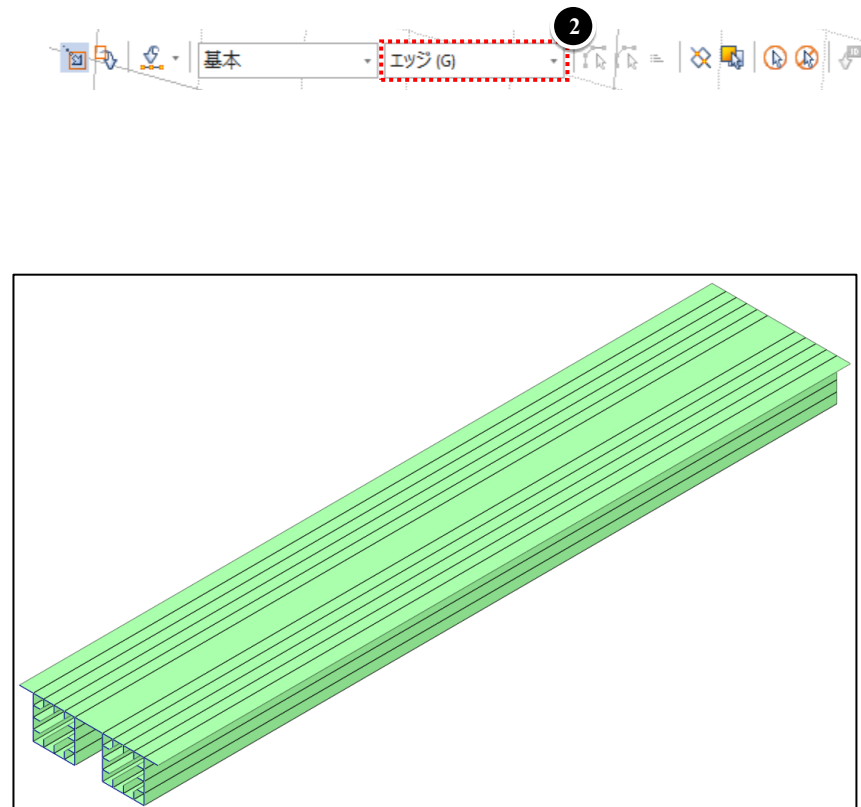
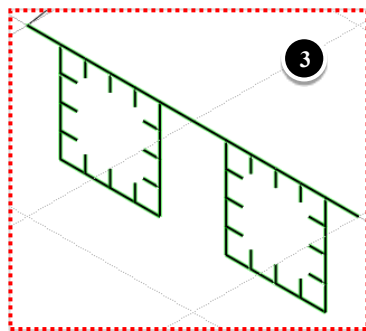

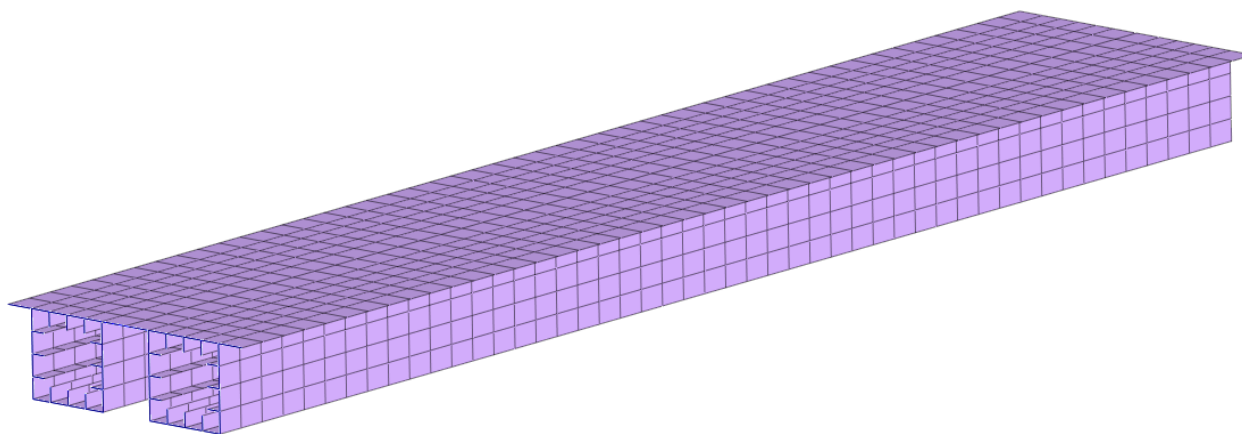
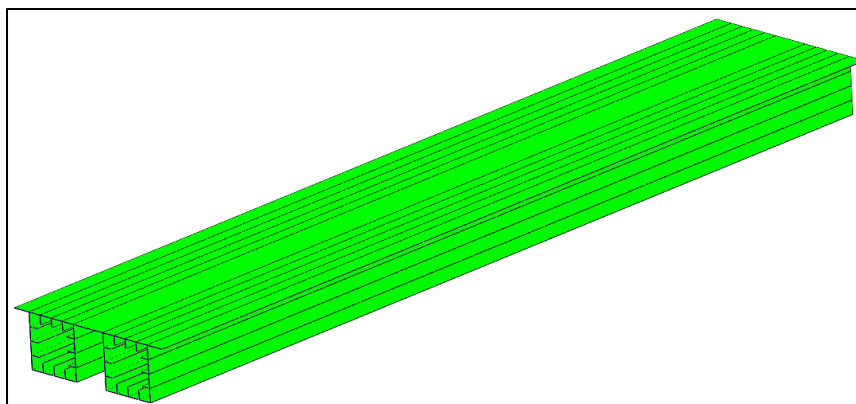
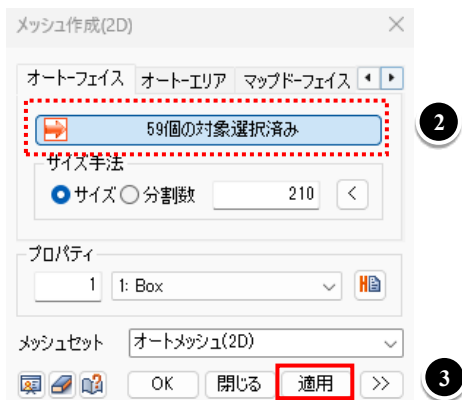

標高データ_ポイント

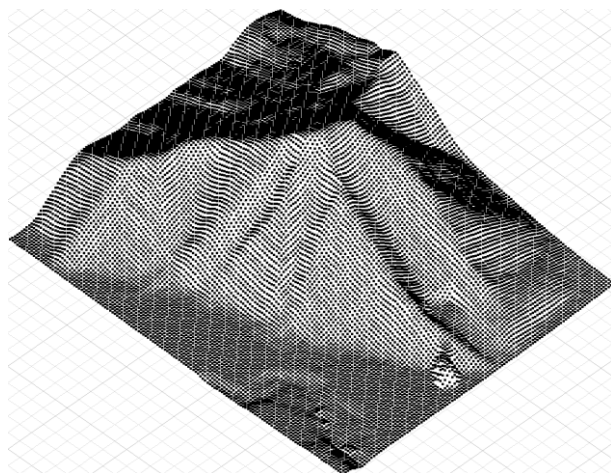

Bサーフェス

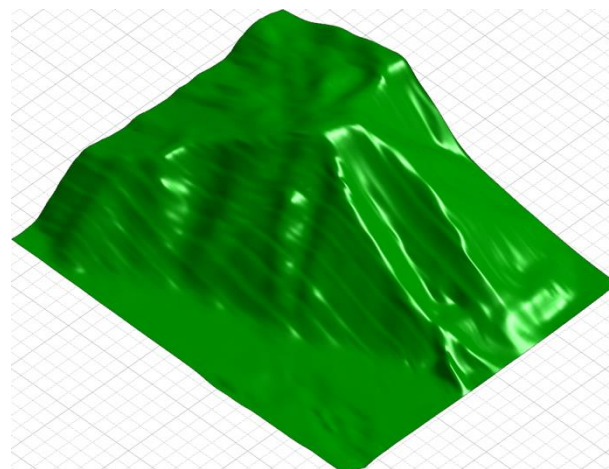

Bスプライン

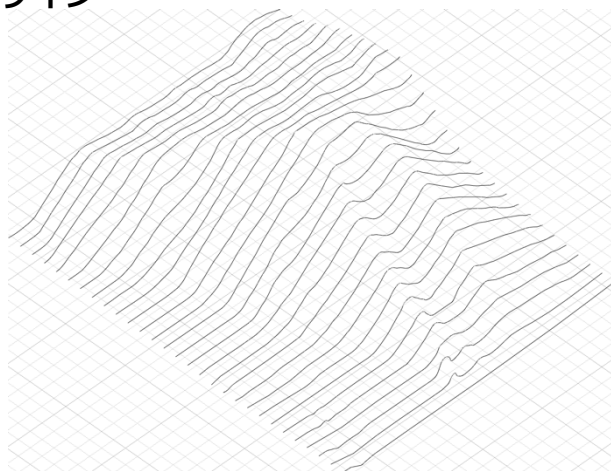

ソリッド

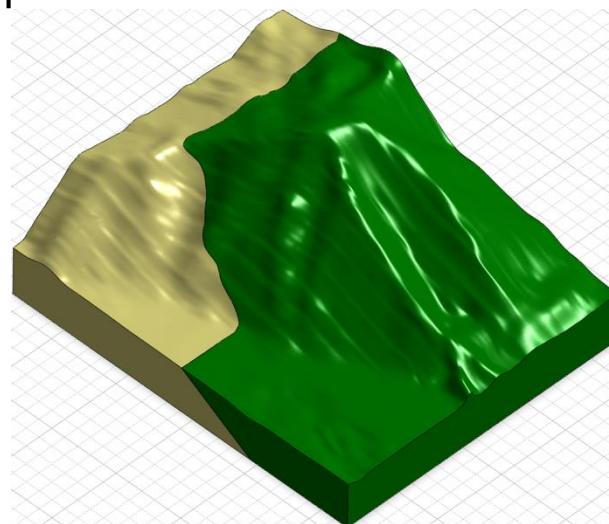

Bサーフェスを用いるモデリング

Bスプライン エッジ

補間ポイントジオメトリ

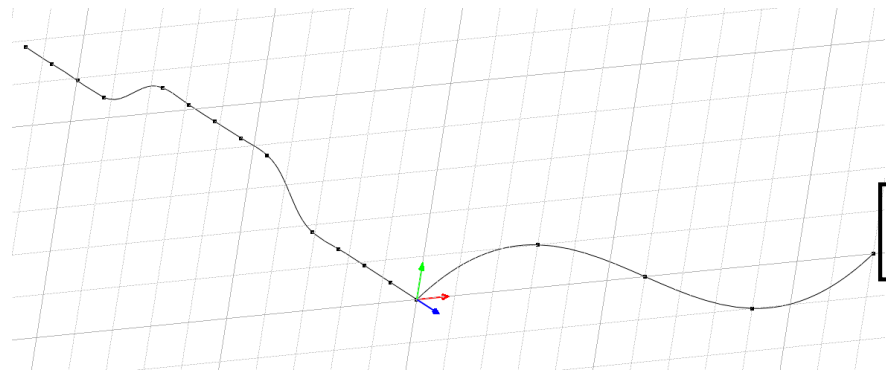
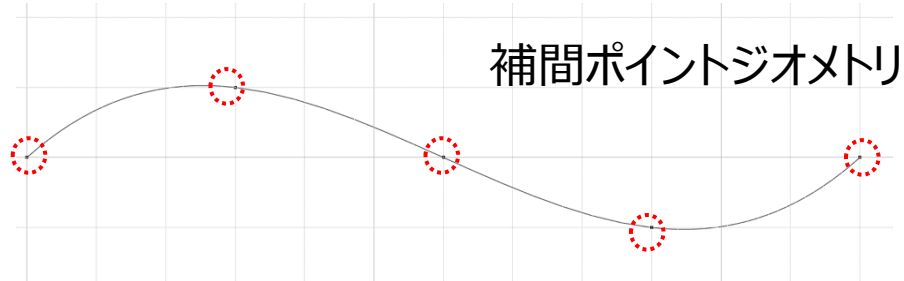

Bサーフェス

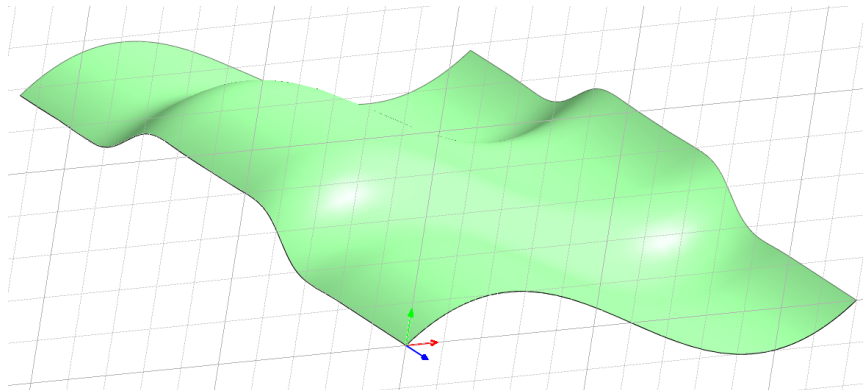

2Dメッシュ化

オートフェイス5分割

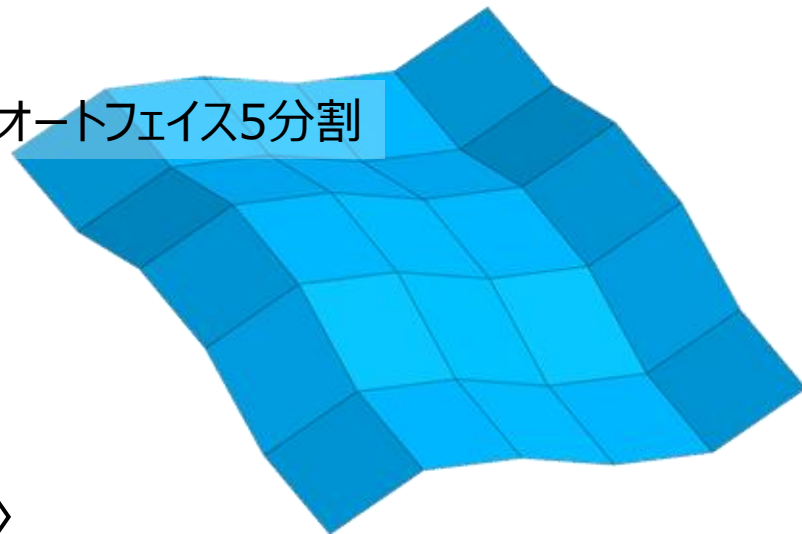

オートフェイス50分割

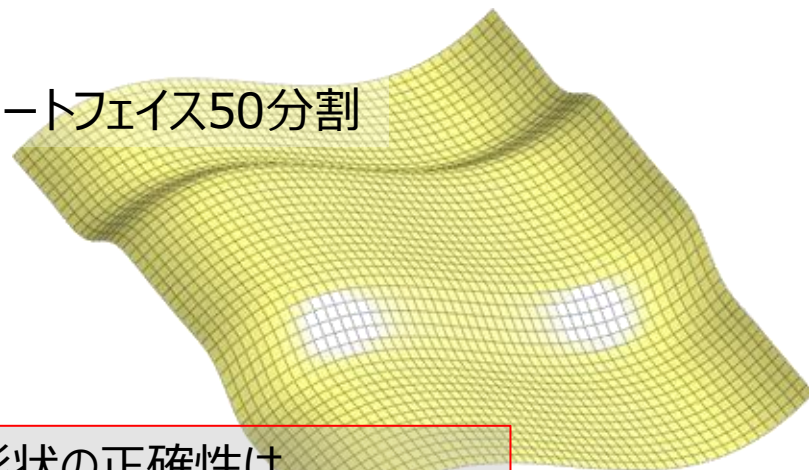

形状の正確性は
メッシュ分割にゆだねる

地盤モデリングにおけるスプラインサーフェスの応用

Bスプライン エッジ



Bサーフェス

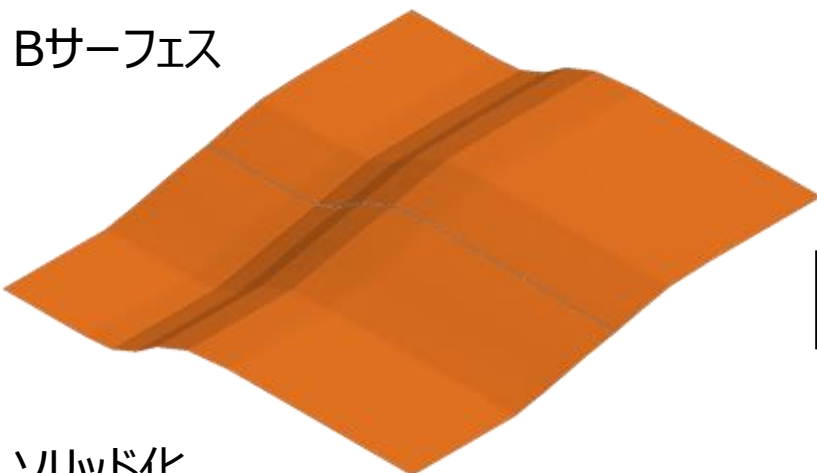

ソリッド化

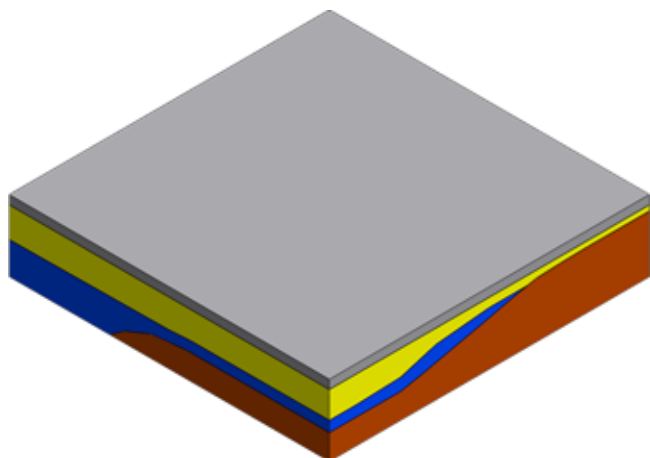

メッシュ化

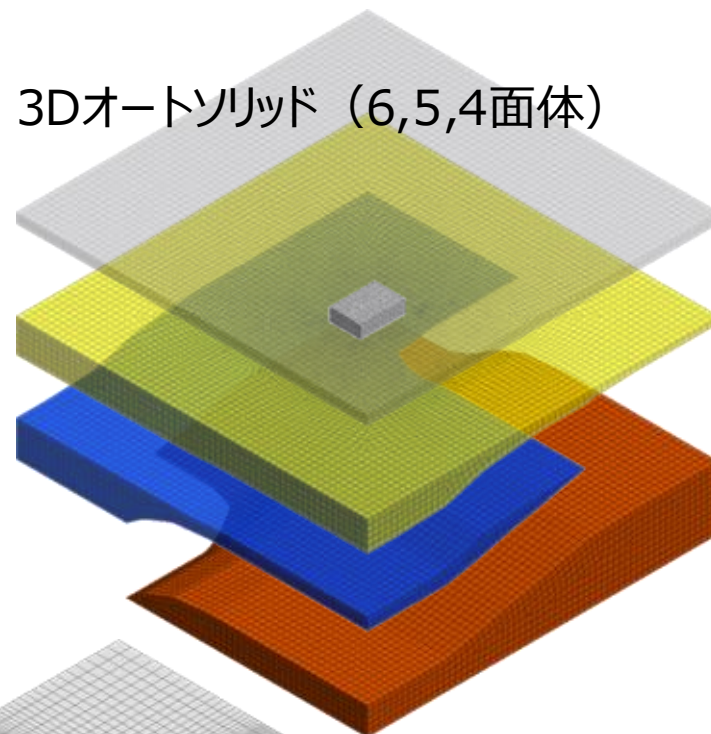

3Dオートソリッド (6,5,4面体)

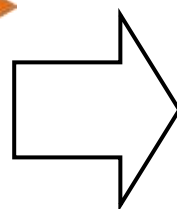

ボクセルメッシュ (6面体)

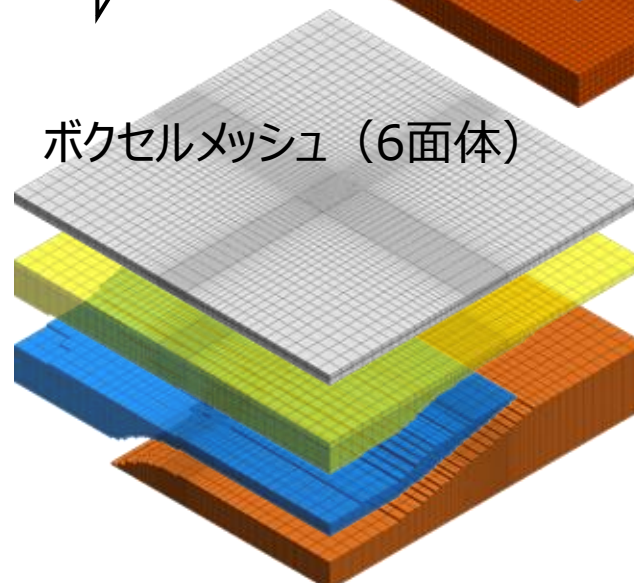

モデルファイル確認

FEA NX

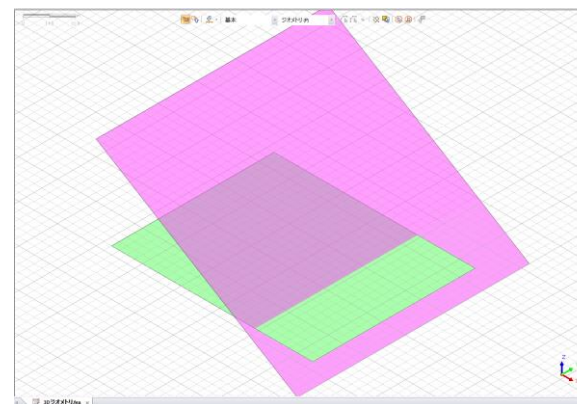
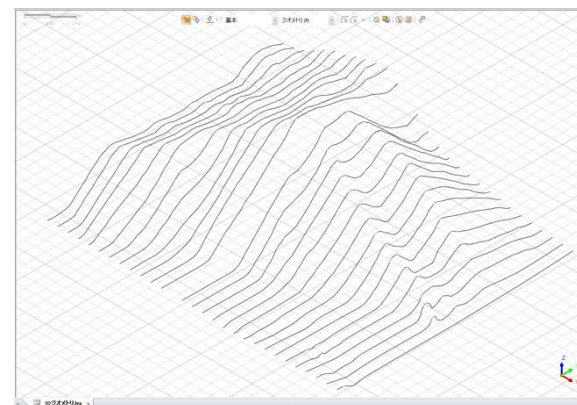
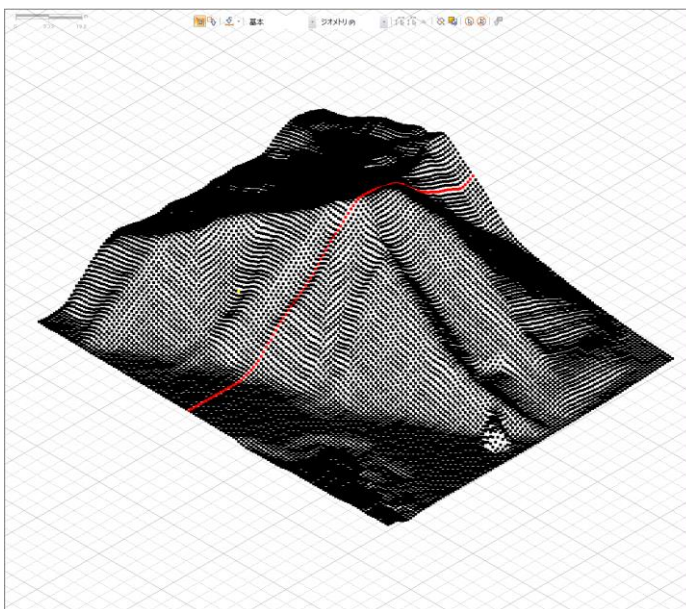
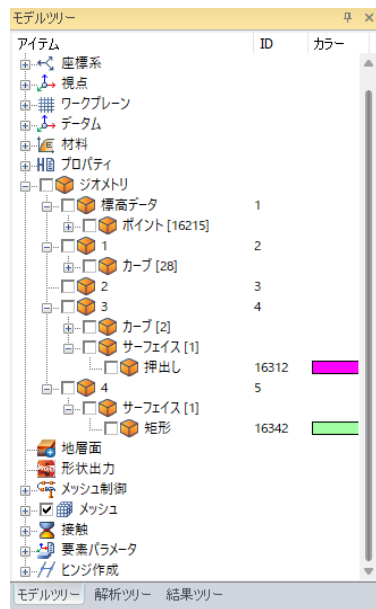

ジオメトリセット確認

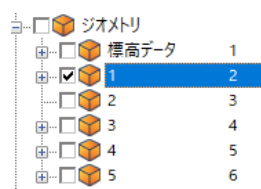
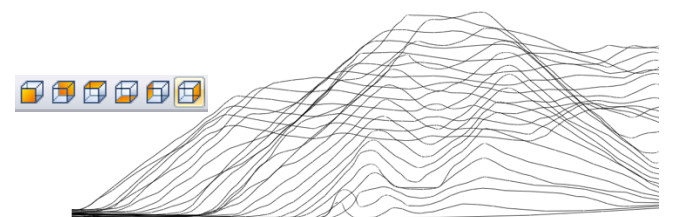
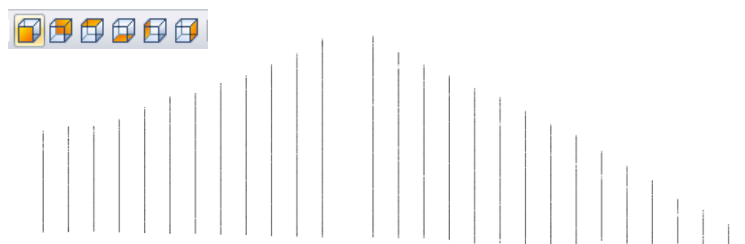
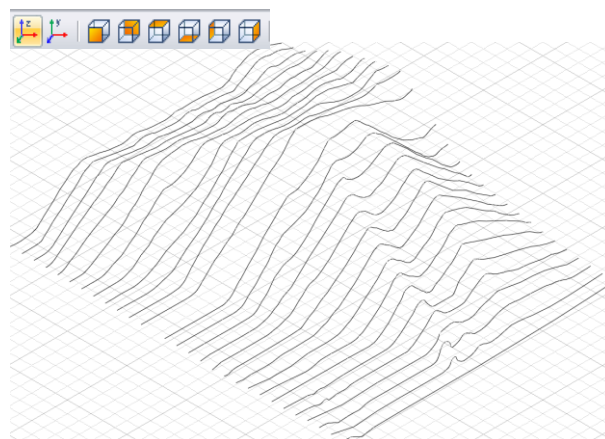
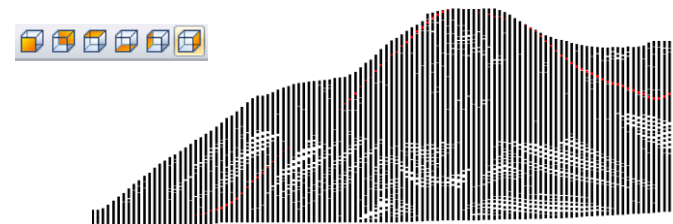
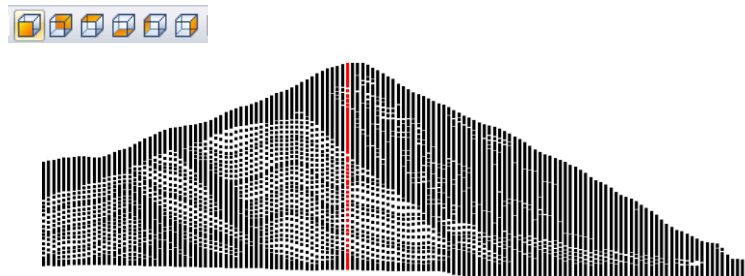
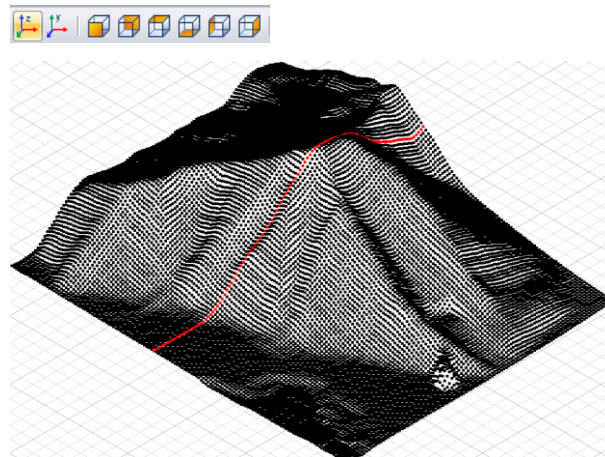
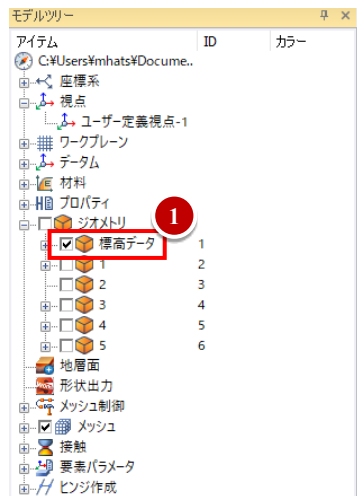



B-スプライン

2D 3D

始点位置の入力
位置 0, 0, 0
手法 座標 x, y, z

多点の連結
115 ポイントの選択済み

手法 ベクトル

順序
 昇順 降順

ベクトル
開始 0, 0, 0
終了 0, 1, 0

フェイス生成
 二点間の接線ベクトル表示

ジオメトリセット 1

戻る OK 閉じる 適用

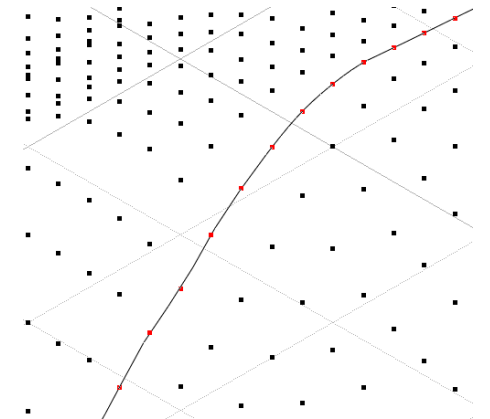
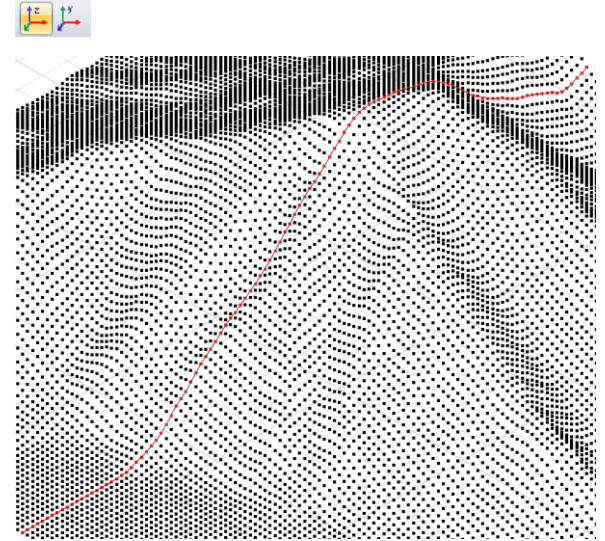
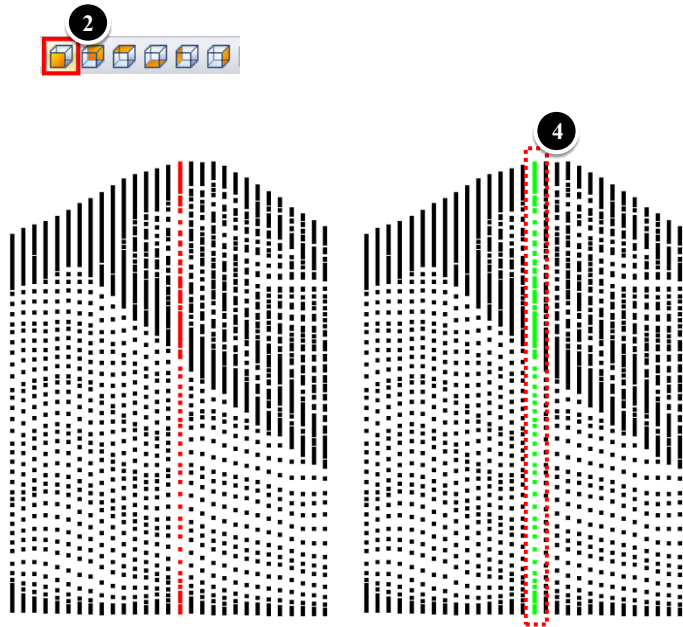

標高データをスプライン補間点にするイメージ

ジオメトリ

<input type="checkbox"/>	標高データ	1
<input checked="" type="checkbox"/>	1	2
<input type="checkbox"/>	2	3
<input type="checkbox"/>	3	4
<input type="checkbox"/>	4	5
<input type="checkbox"/>	5	6



基本

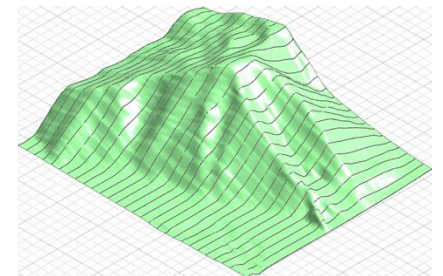
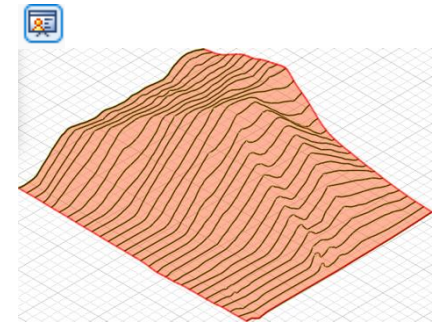
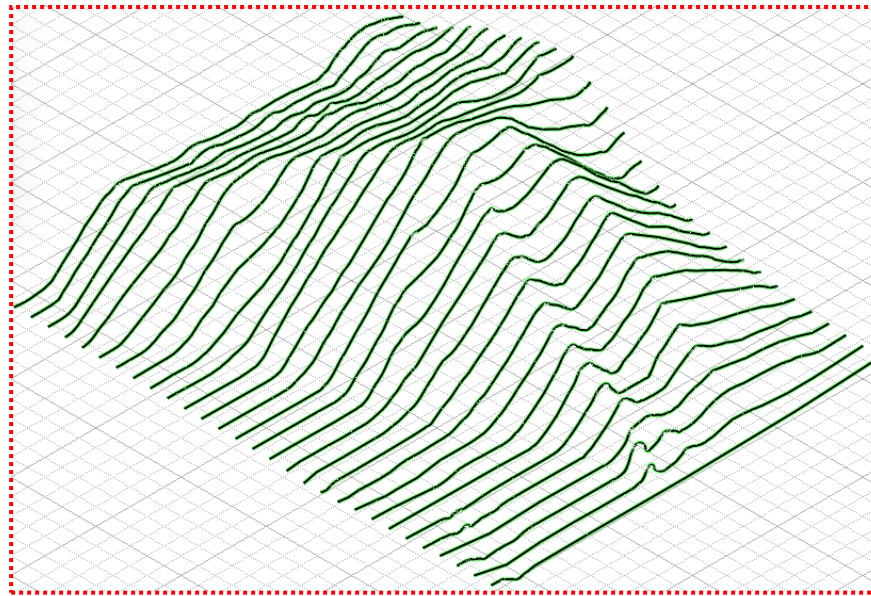
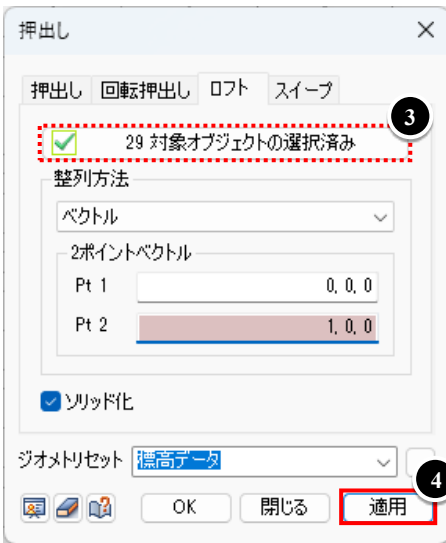
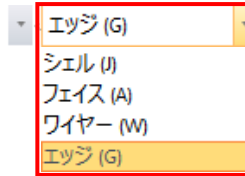

押し出し:フェイス

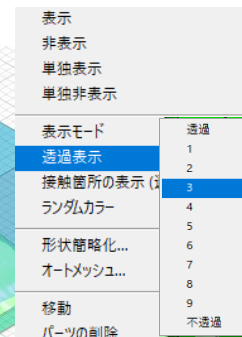
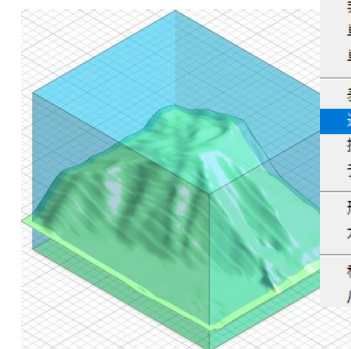
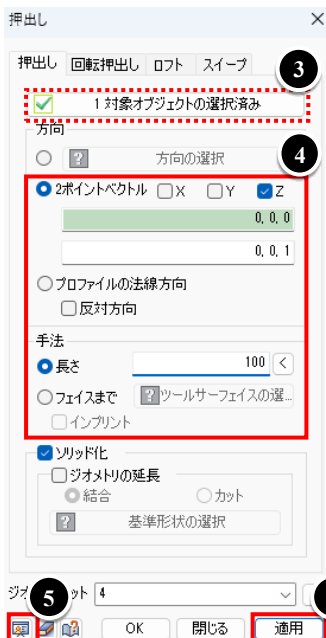
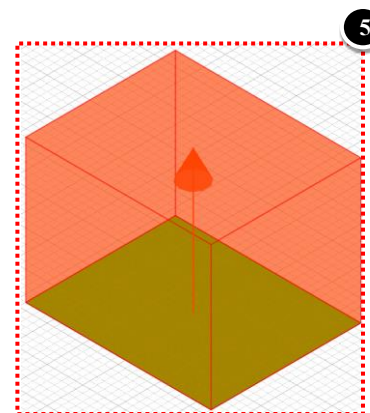
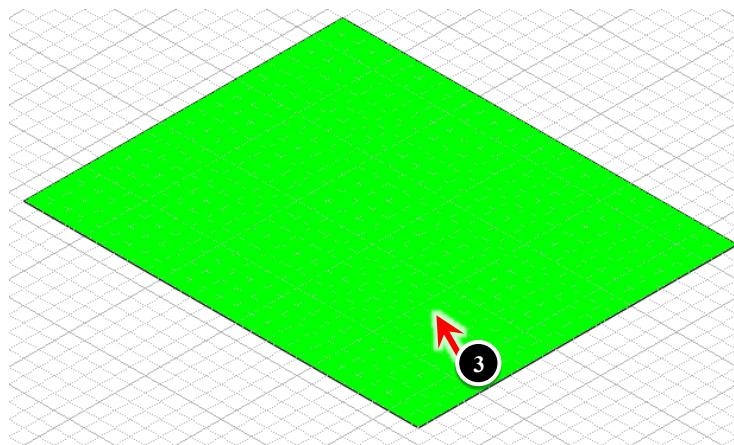

分割ソリッド

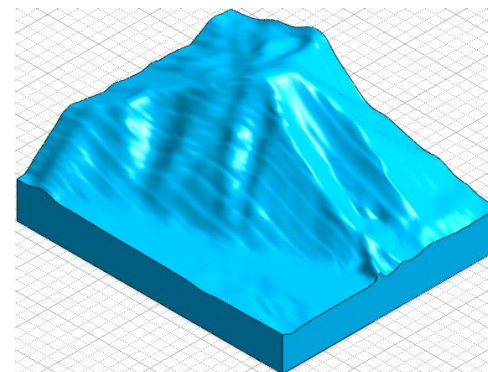
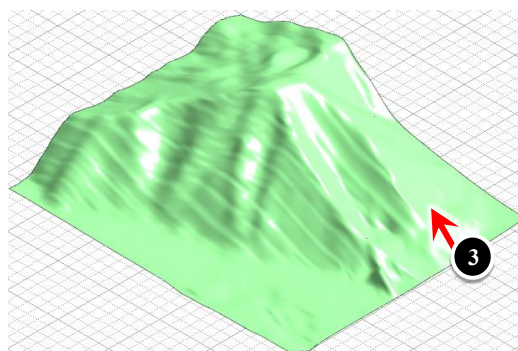
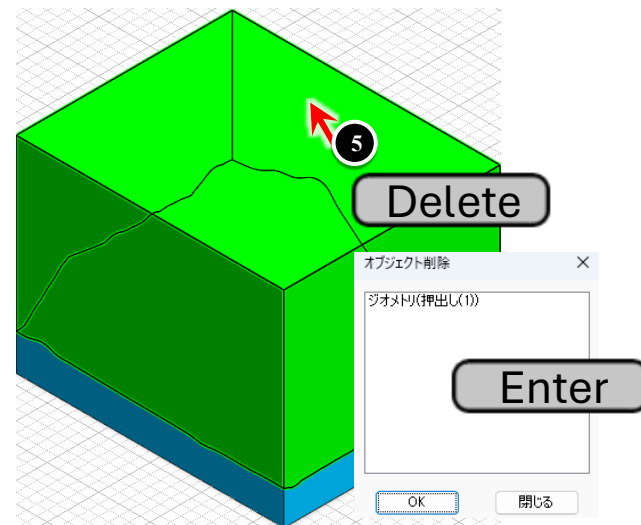
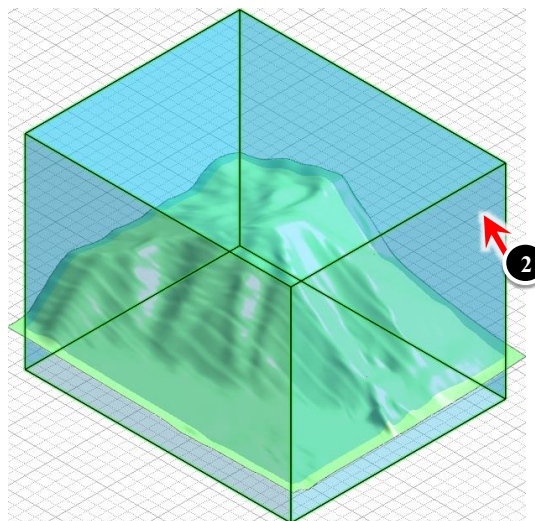
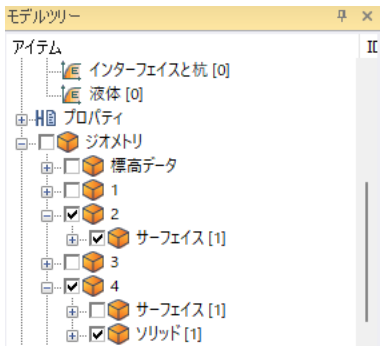

分割ソリッド

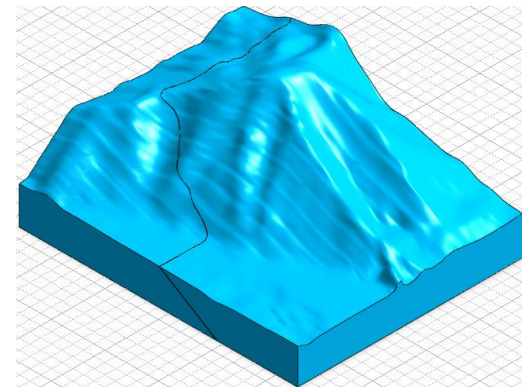
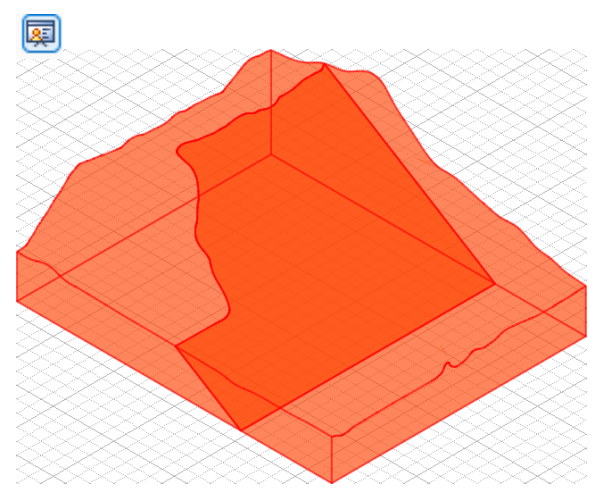
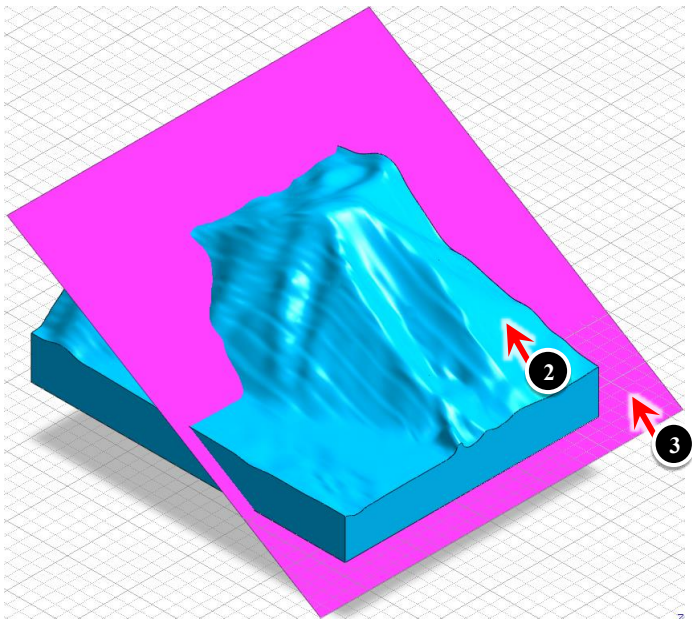
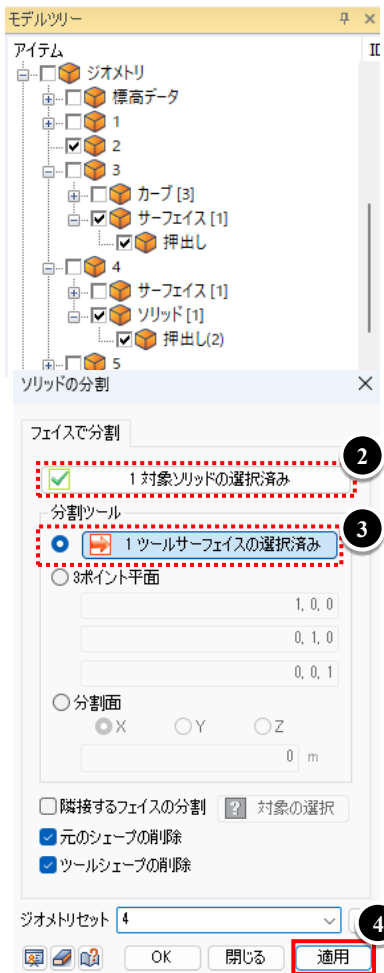

オートソリッド/色変更

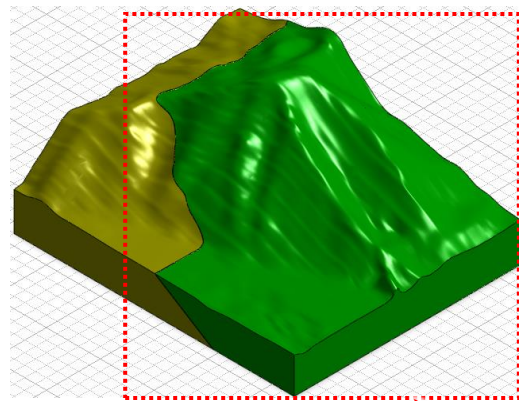
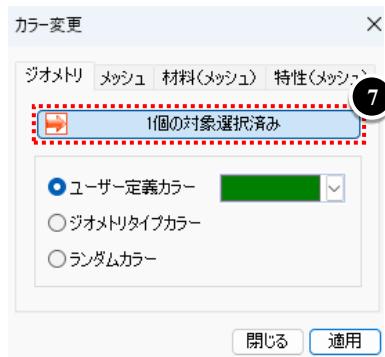
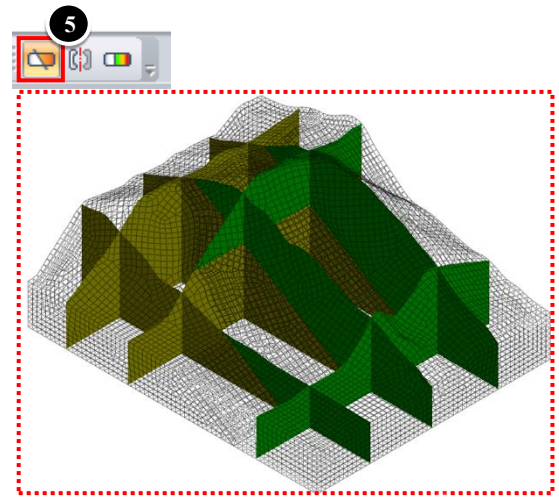
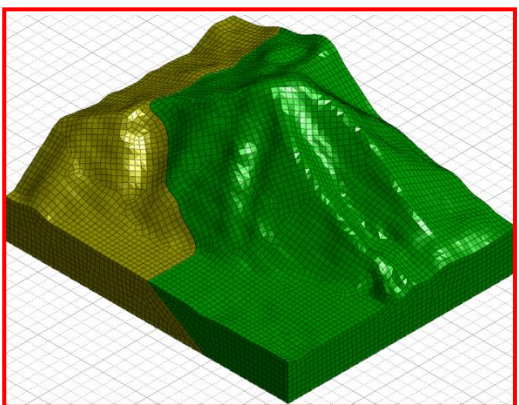
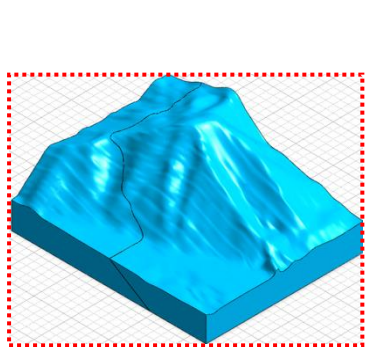
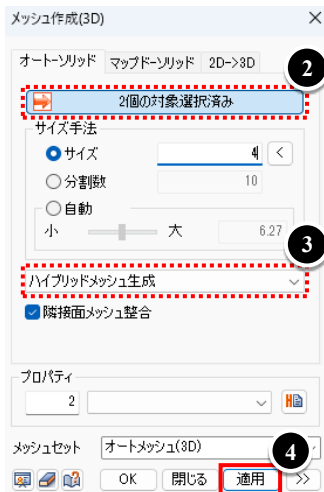

SESSION

3

2D解析

- 土留め掘削/強制変位

土留め弾塑性法（梁バネ）
変位結果

FEM解析

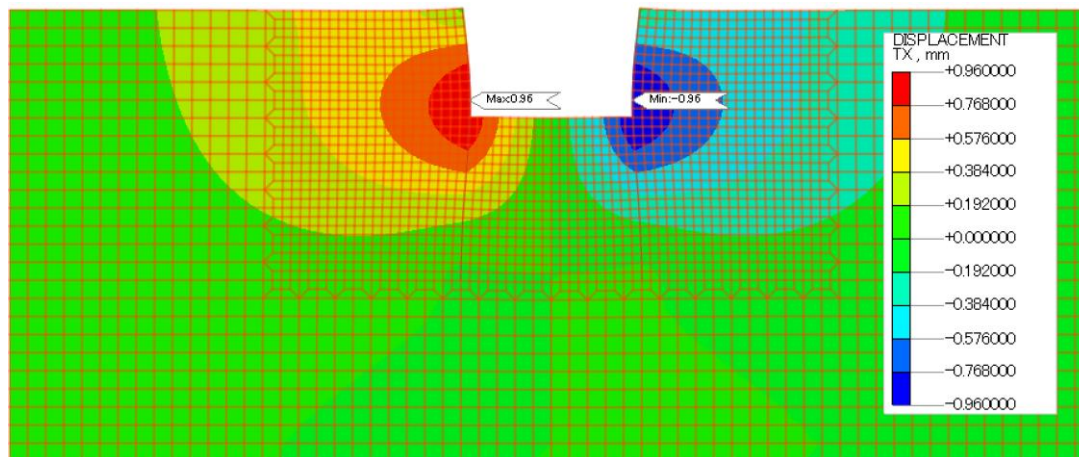
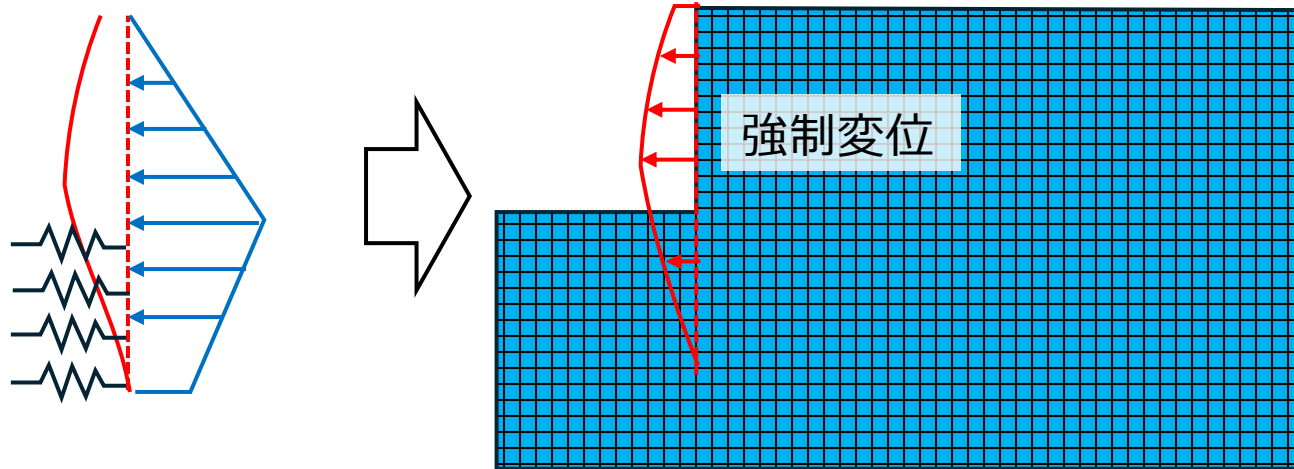

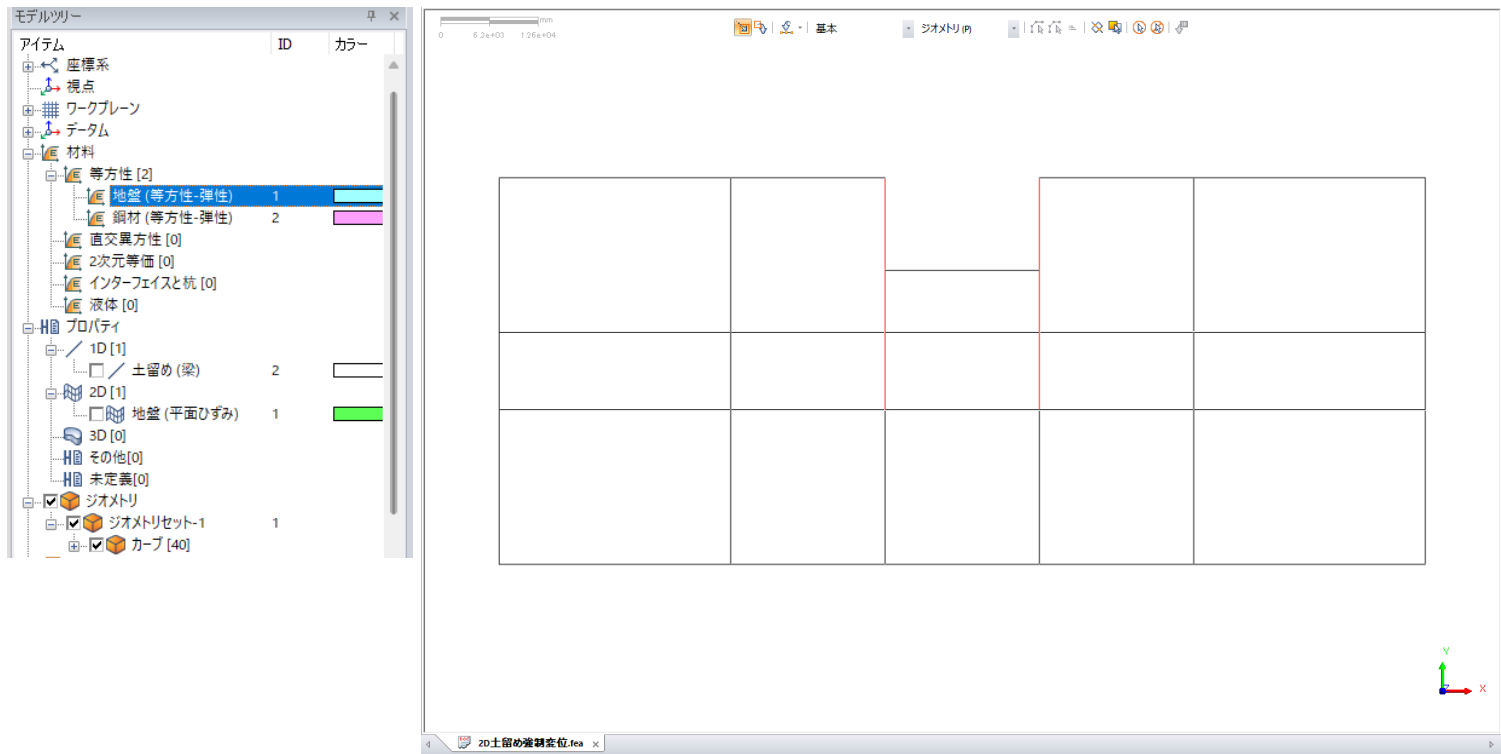

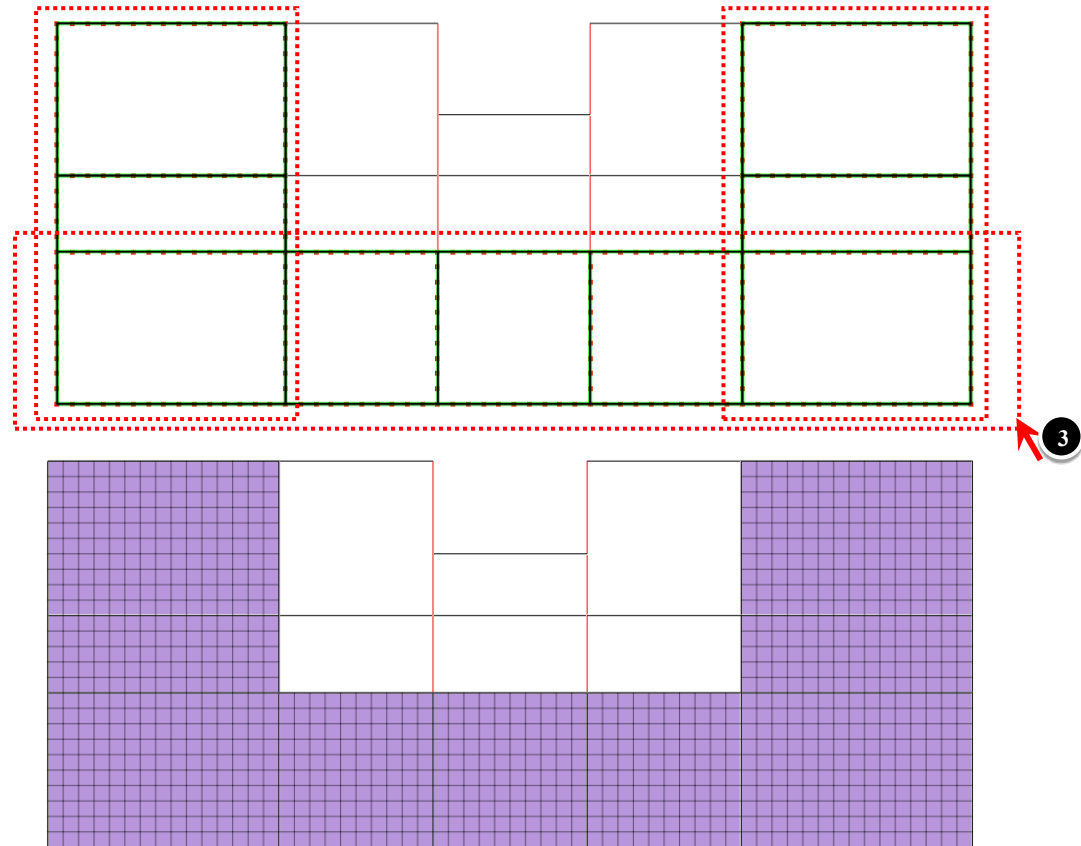
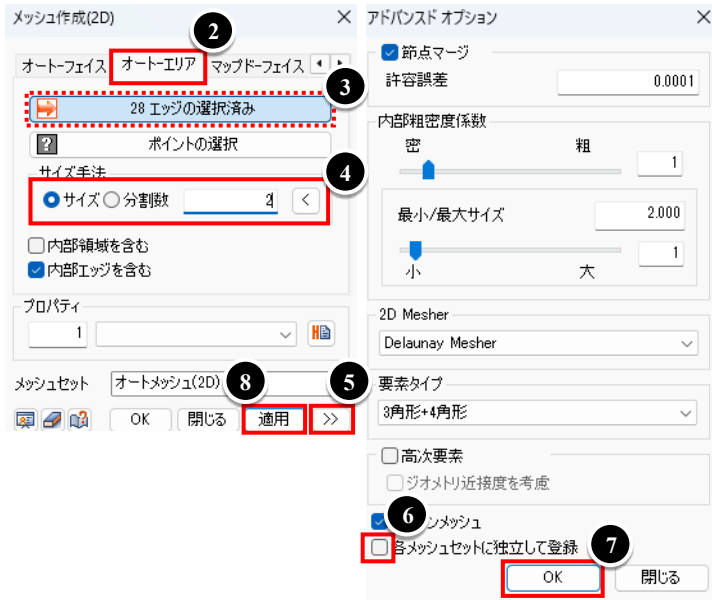

メッシュ分割

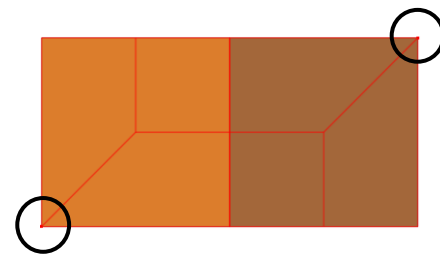
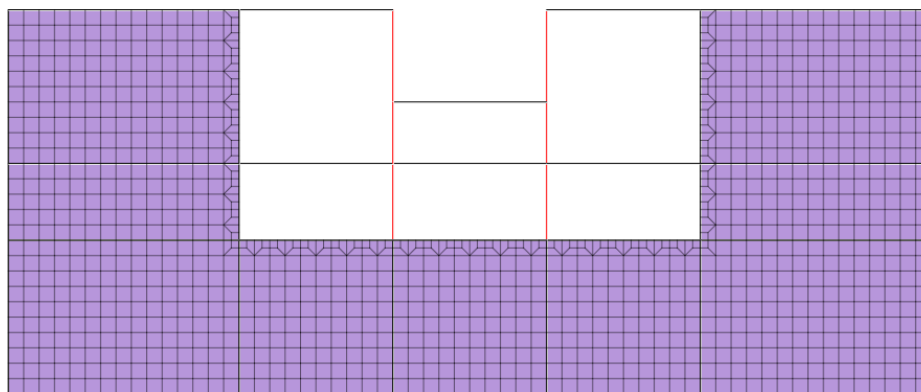
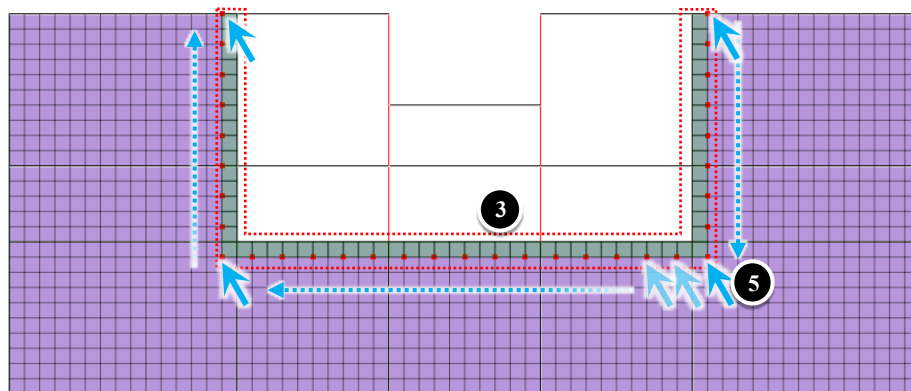

メッシュ分割

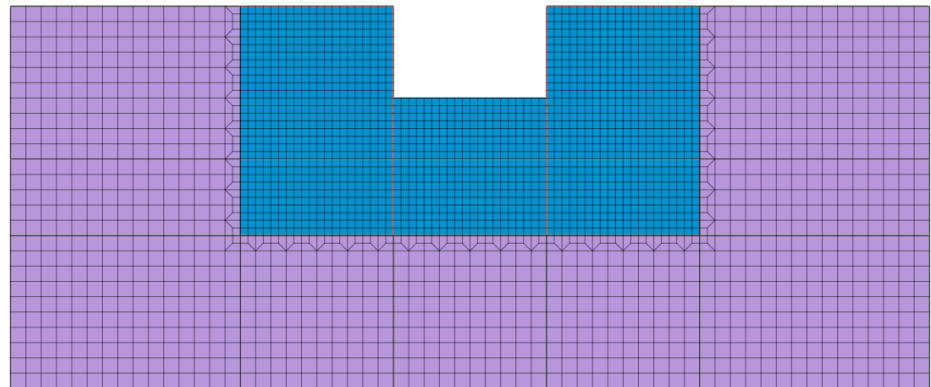
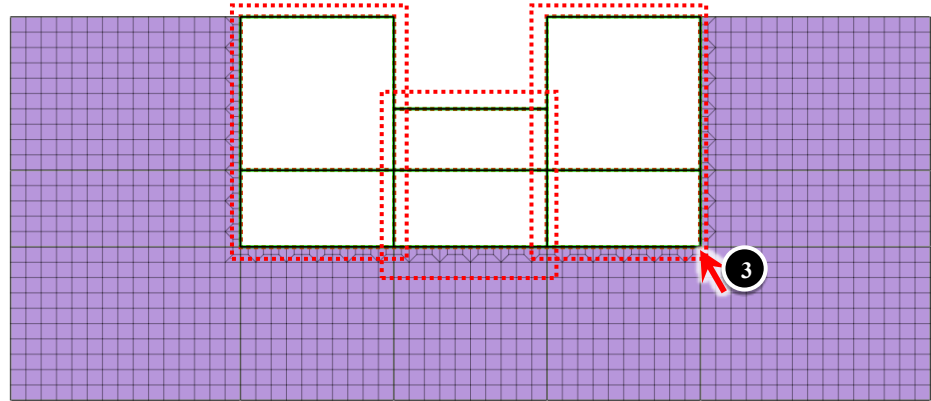
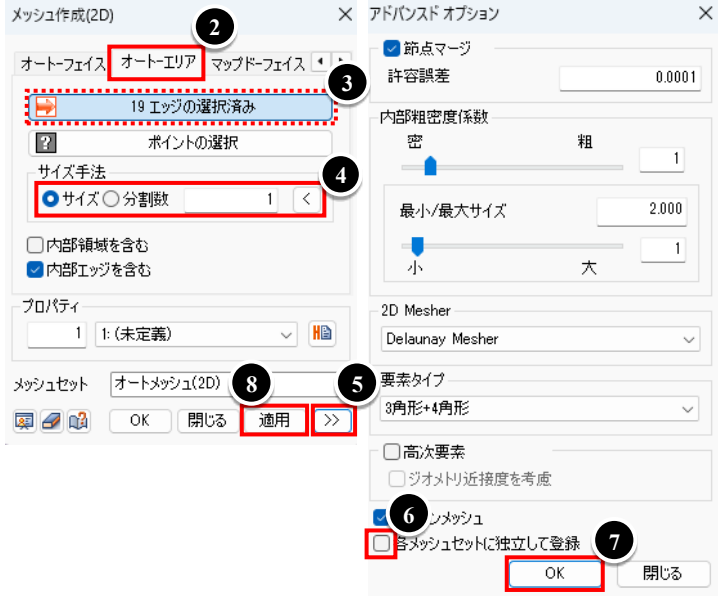

メッシュセットマージ

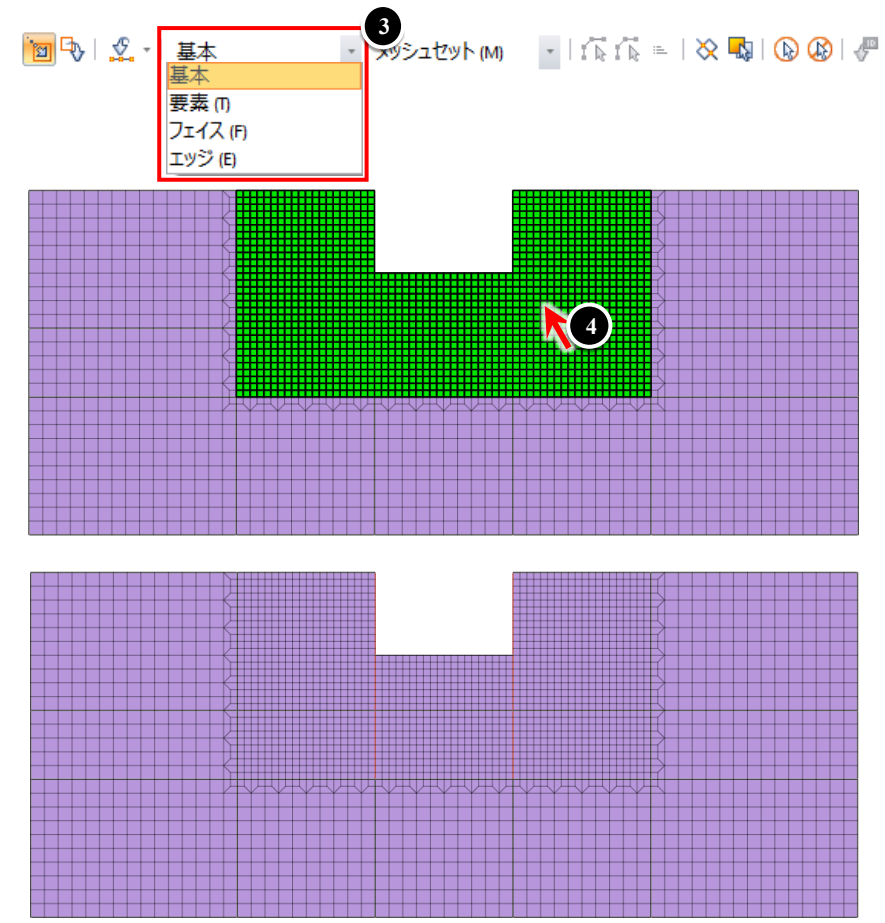
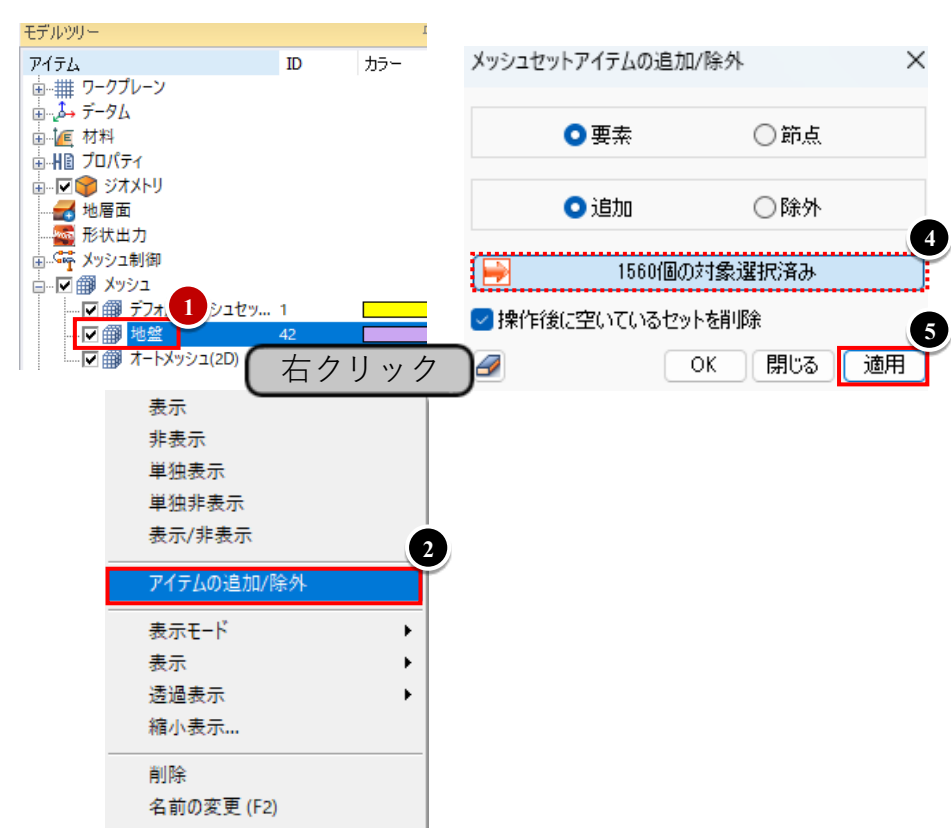
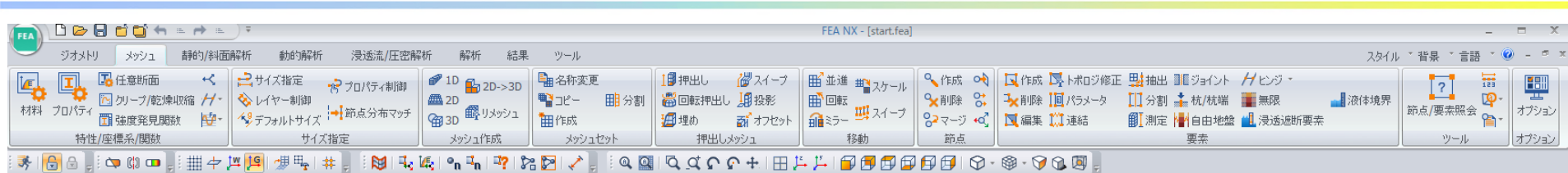

1D要素抽出

FEA NX

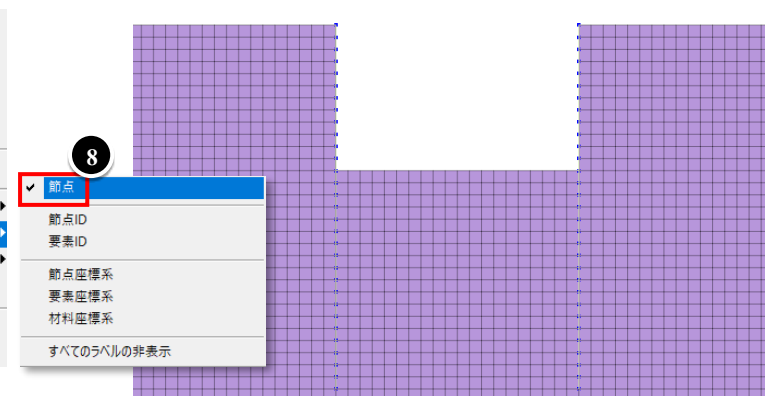
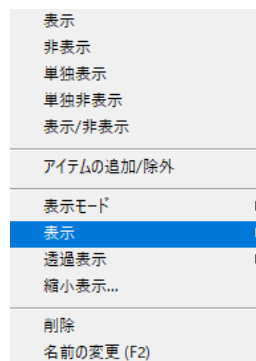
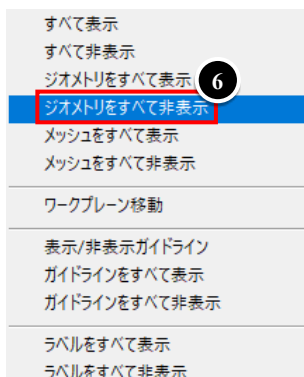
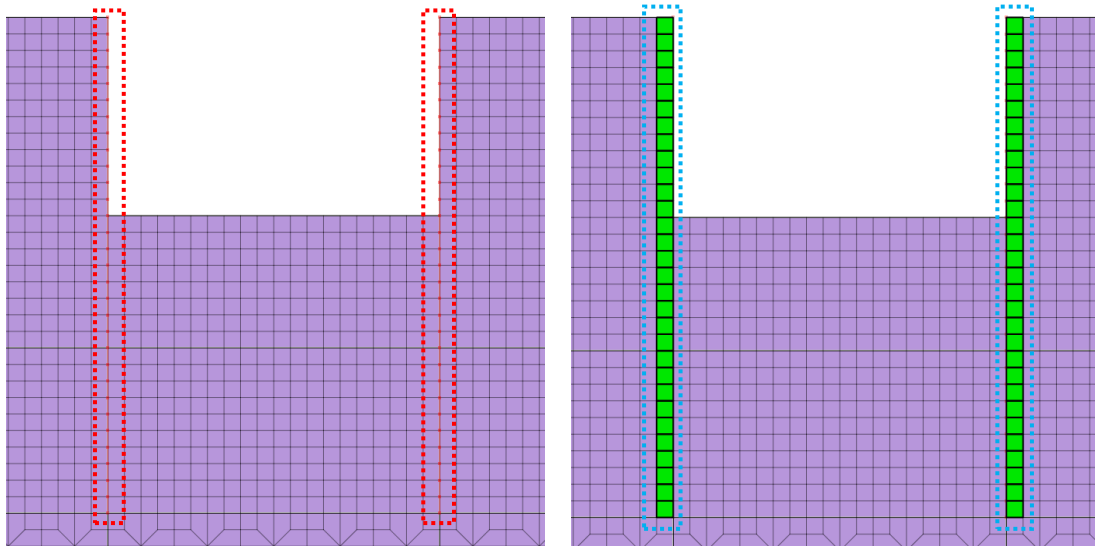
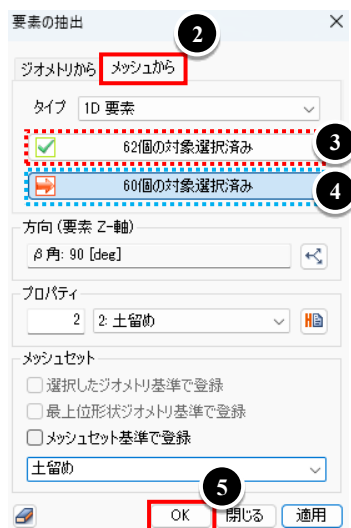

変位拘束

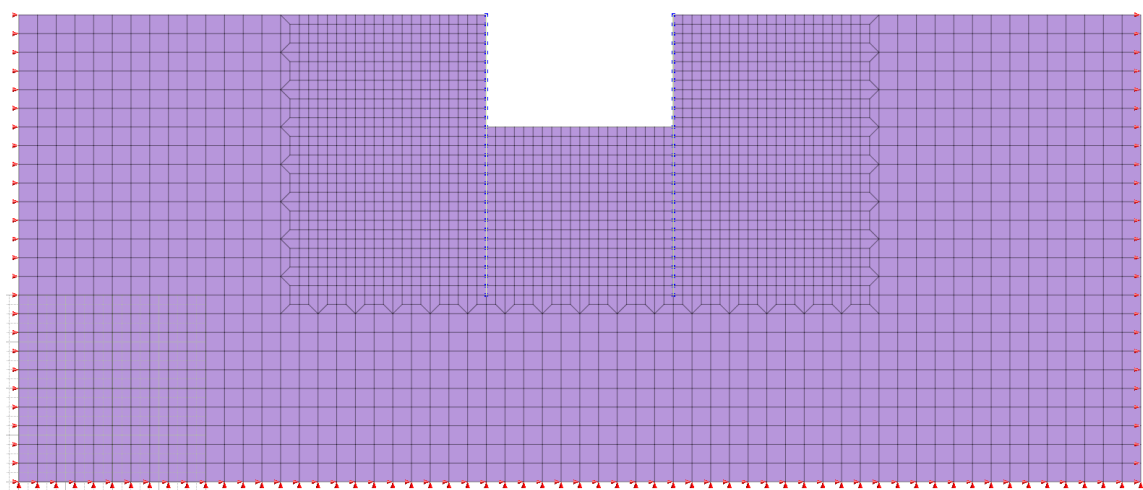
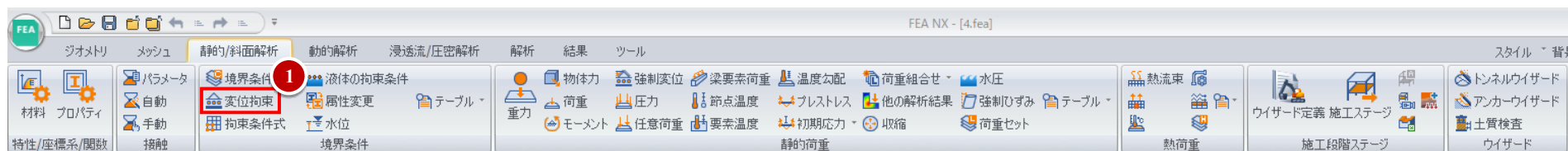

X座標 : 最大値, 最小値 Tx固定
Y座標 : 最小値 Tx,Ty固定

関数作成/土留め変位



	A	B	C	D
		座標	水平変位[m]	
1				
2		50.00	0.00014	
3		49.50	0.00020	
4		49.00	0.00026	
5		48.50	0.00032	
6		48.00	0.00037	
7		47.50	0.00043	
8		47.00	0.00048	
9		46.50	0.00053	
10		46.00	0.0	
11		45.50	0.0	
12		45.00	0.00068	
13		44.50	0.00073	
14		44.00	0.00077	
15		43.50	0.00081	
16		43.00	0.00084	
17		42.50	0.00087	
18		42.00	0.00090	
19		41.50	0.00092	

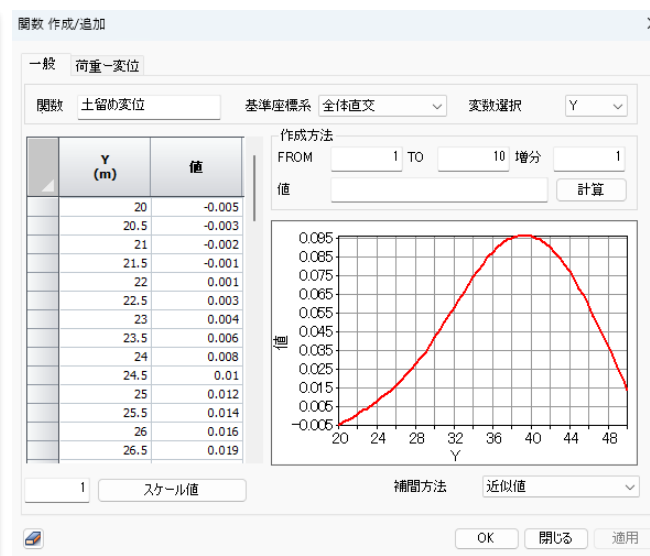

[一般関数]は座標依存の関数を作成します。
Y[m]はGL-ではなくモデル上の座標で設定します。

データ範囲外の補間方法

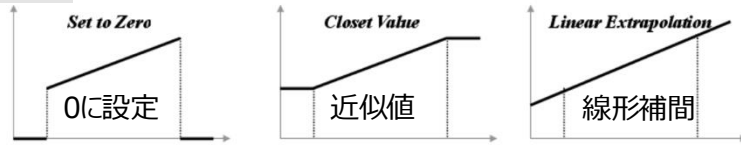
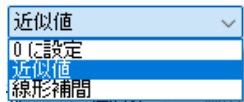

強制変位/関数作成

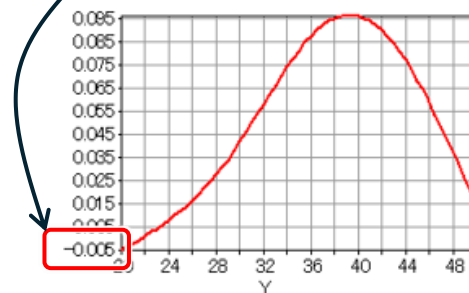
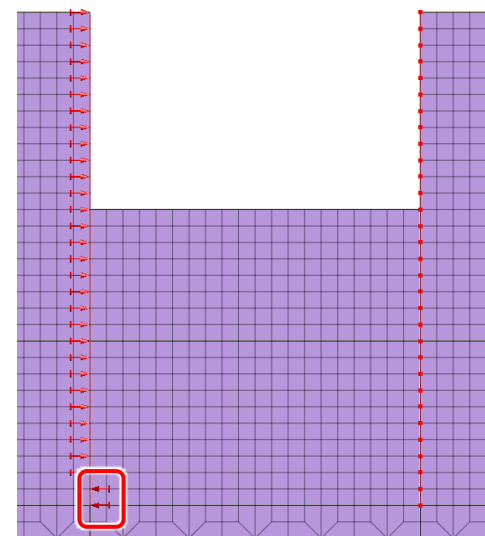
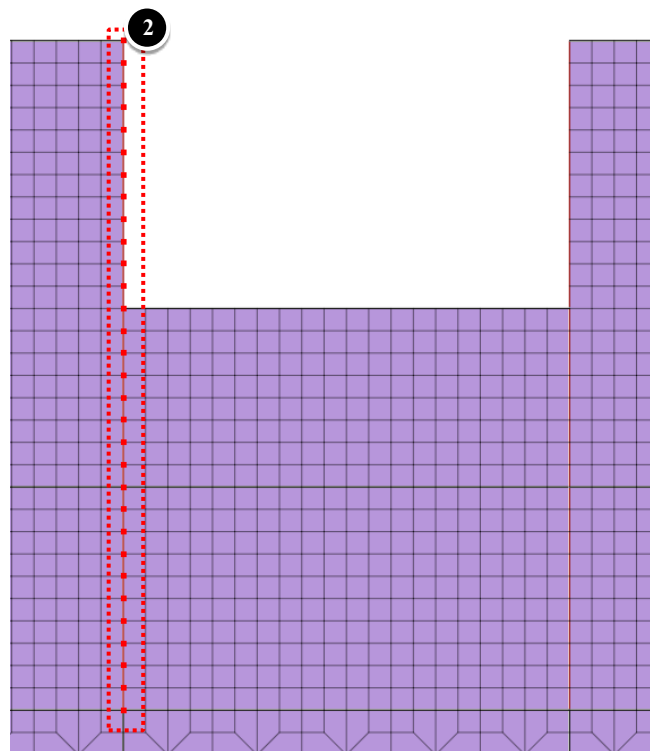
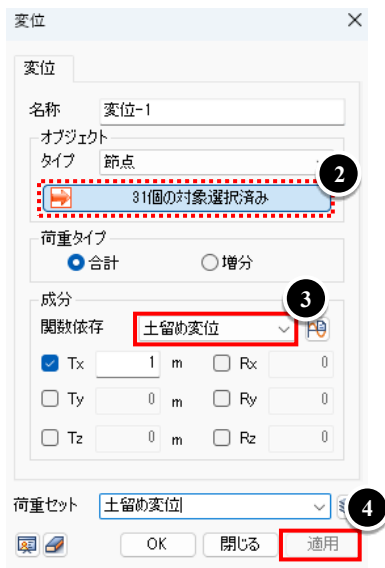

矢印確認
極性が変わる箇所がある

強制変位

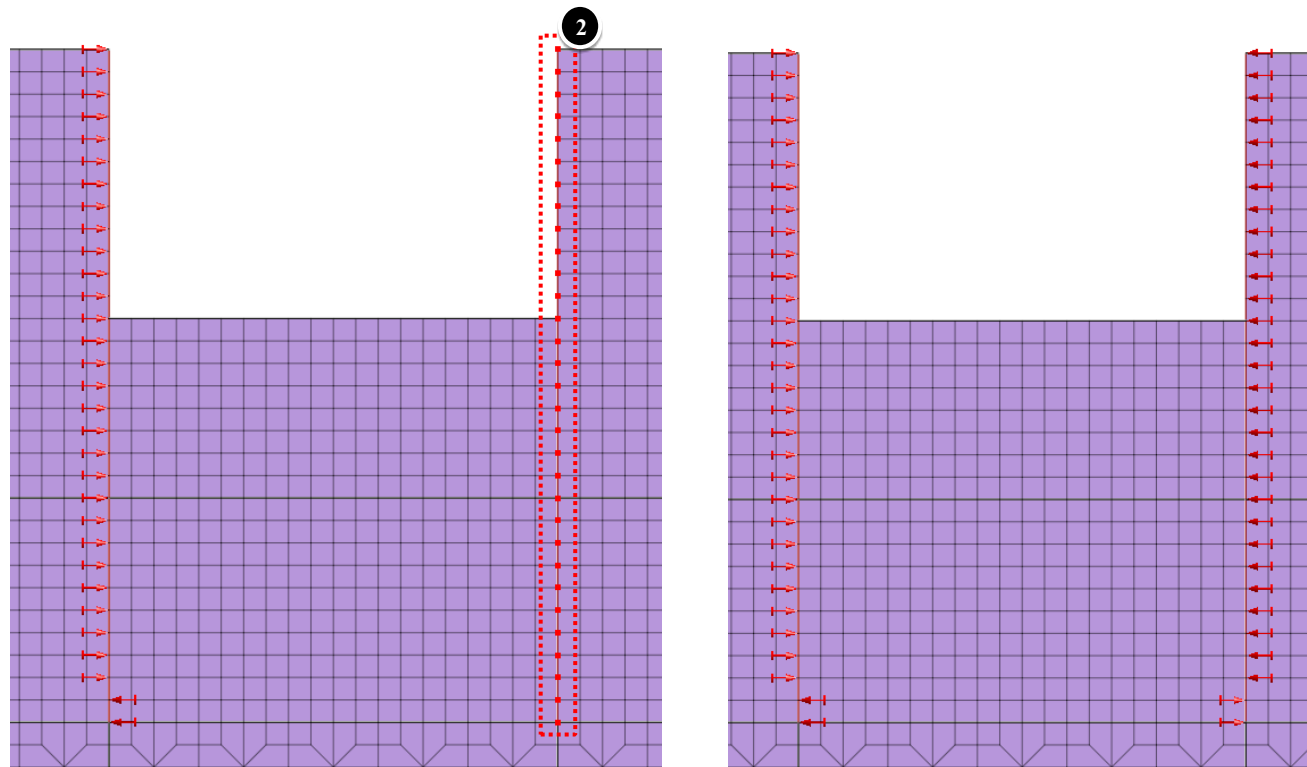
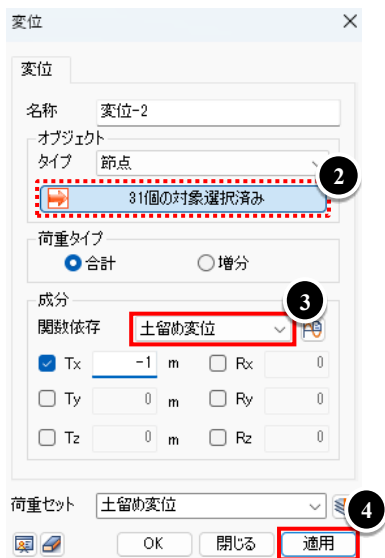
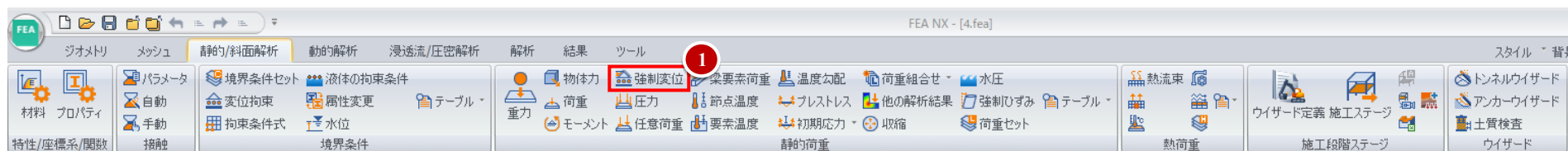

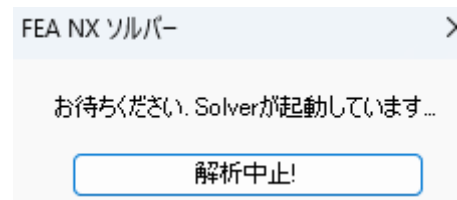
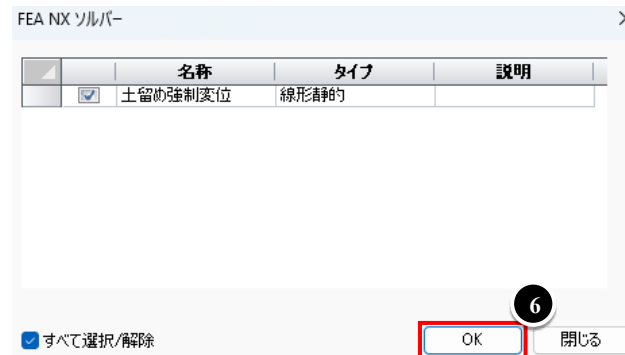
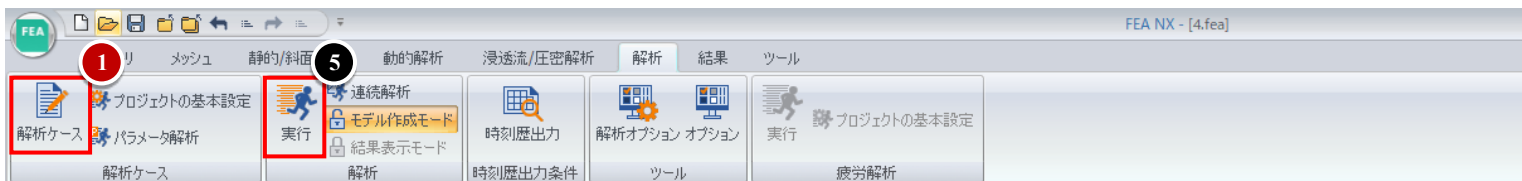

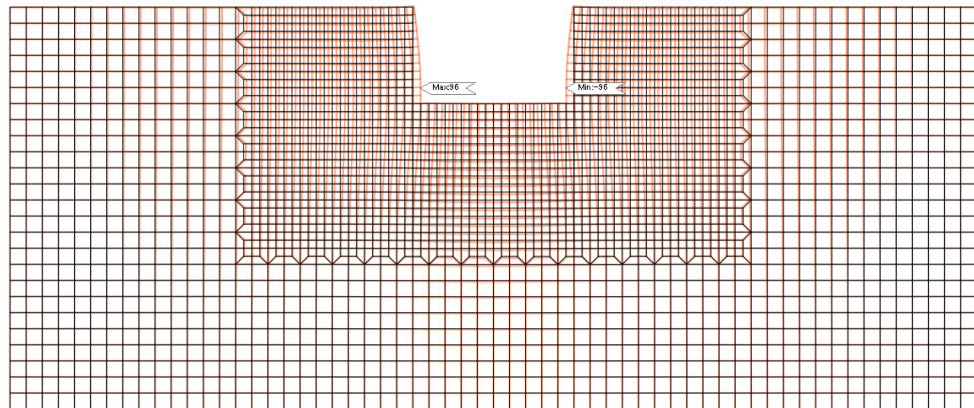
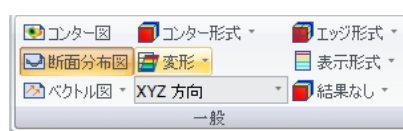
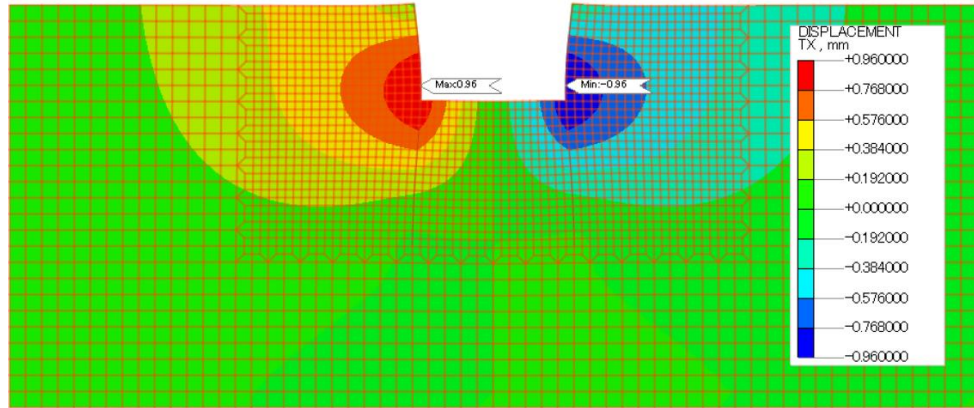
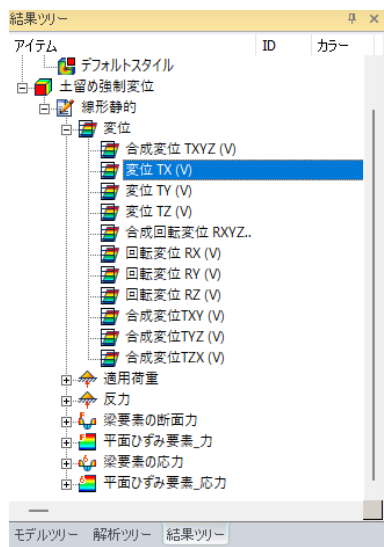

- 変形前
- 変形後
- 変形前+変形後(ワイヤーフレーム)
- 変形前+変形後(フィーチャーエッジ)
- 変形前+変形後(シェーディング)
- 変形前+変形後(透過表示)

プロパティ	
変形	
変形	
シェーブタイプ	変形後+変形前 (ワイヤーフ...
方向	XYZ 方向
スケール	10
<input checked="" type="checkbox"/> 実際変位	True
変形前形状	

FEA NXで学ぶ
初心者向けFEM解析体験セミナー

MIDAS

SESSION

4

3D解析

- 鉄骨/非線形静的

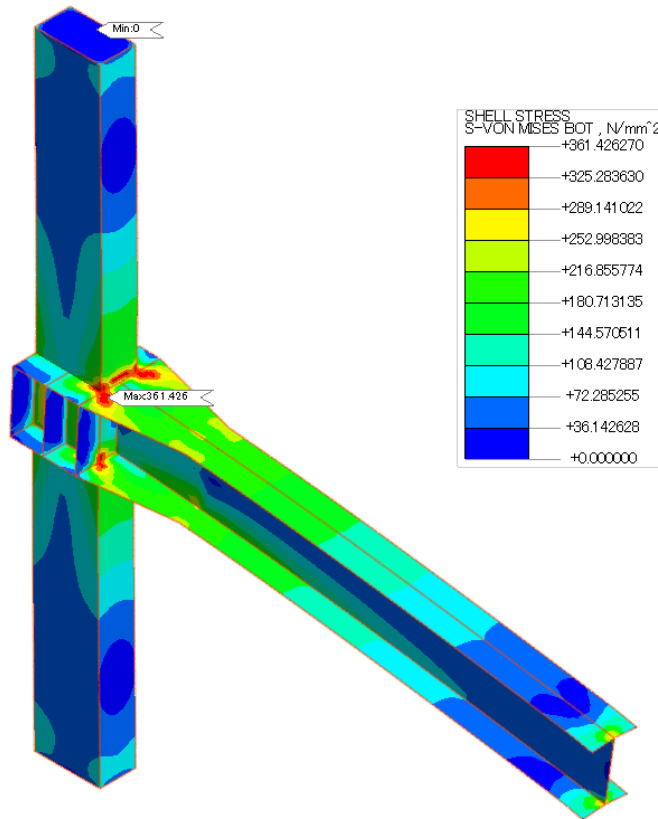

Von mises

材料

ID 1 名称 等方性 カラー

モデルタイプ von Mises 構造

一般 非線形 温度特性 時間依存 温度依存

完全塑性
降伏応力 395 N/mm²

硬化開始 なし

応力-ひずみ関係 なし

硬化則 等方性

硬化開始組合せ (0~1) 0

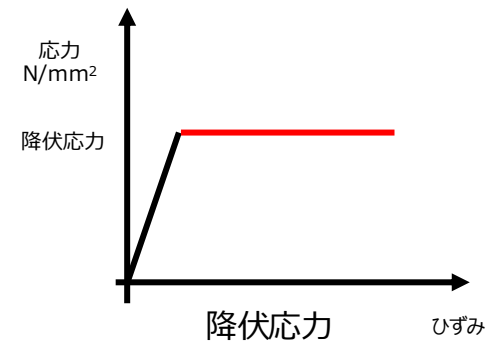
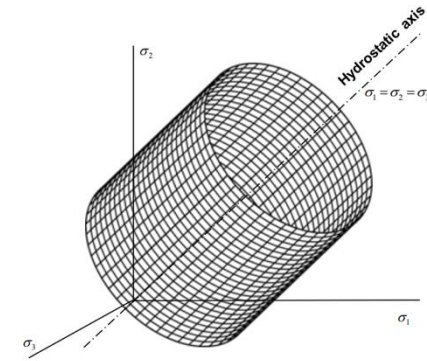

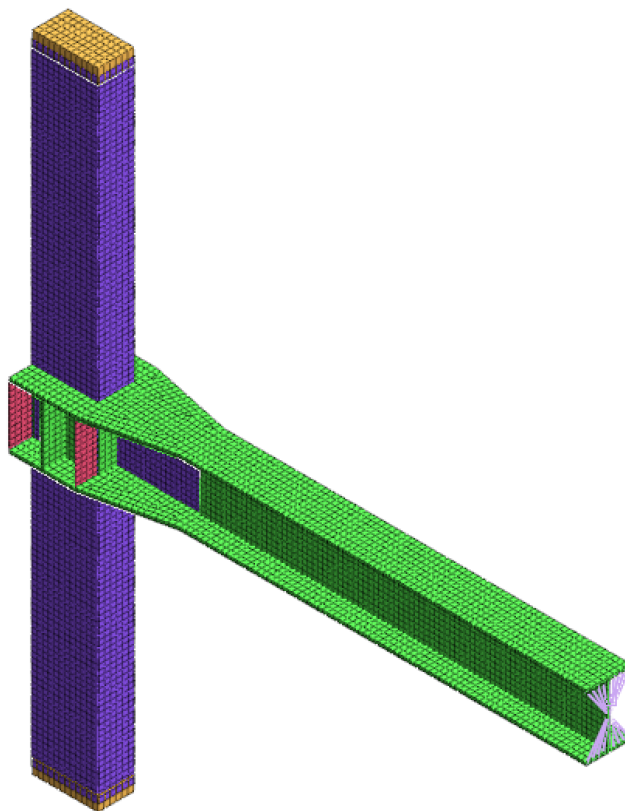
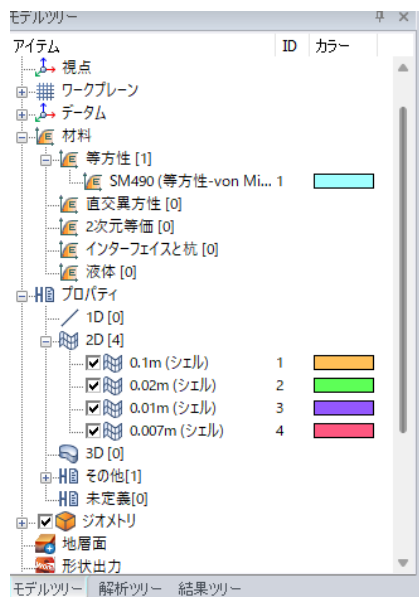

剛体連結作成

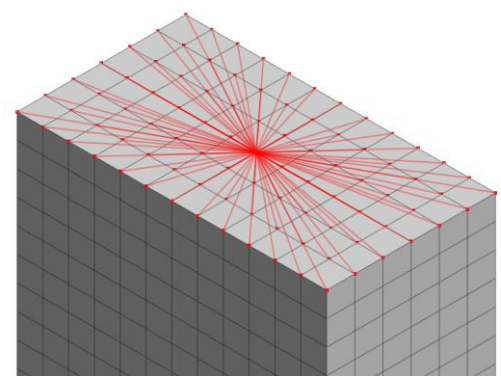
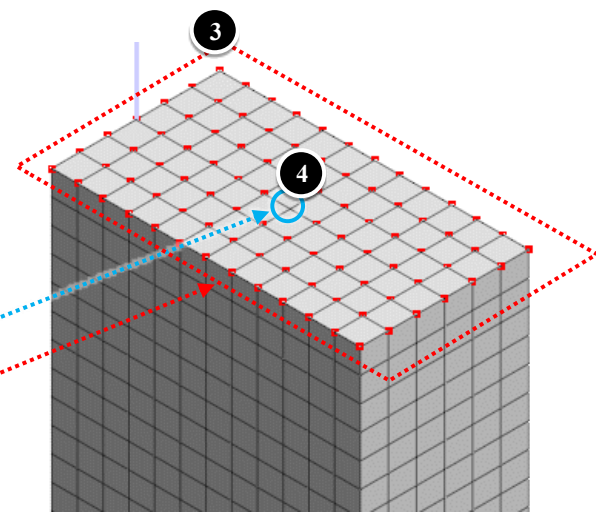
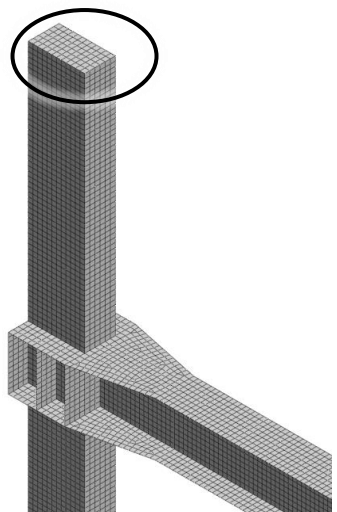

剛体連結作成

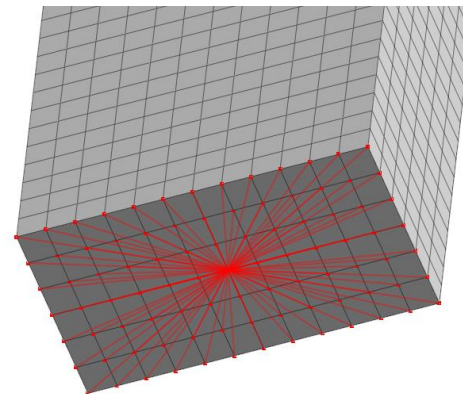
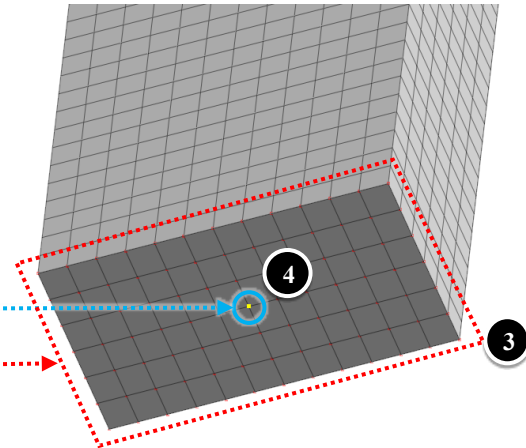
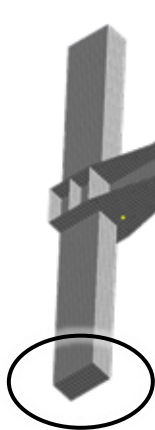

拘束条件

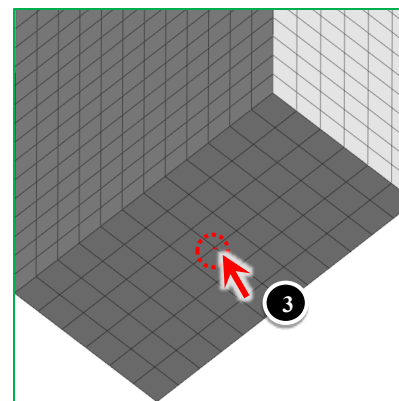
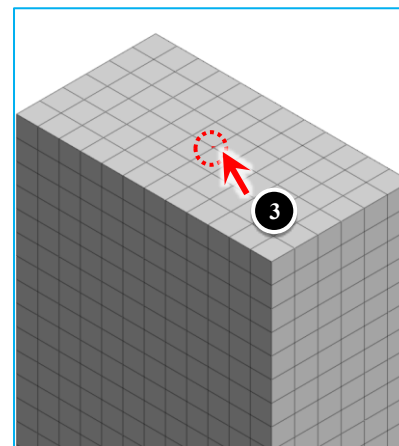
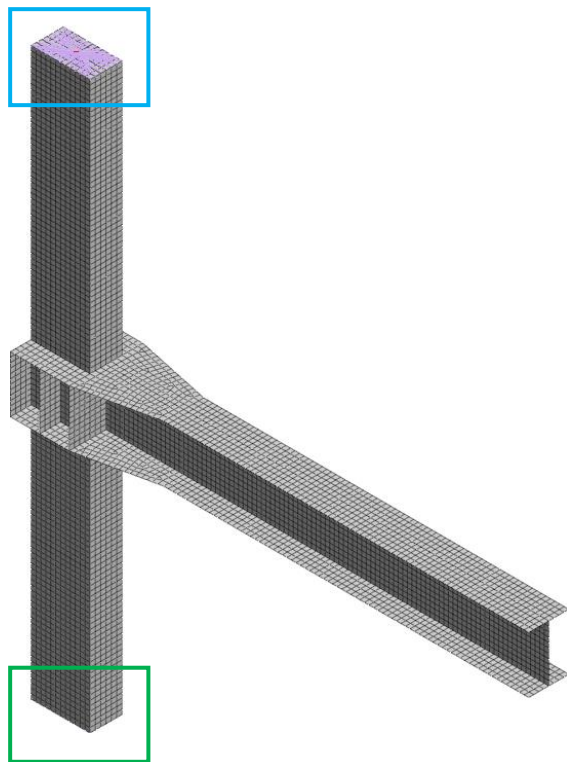
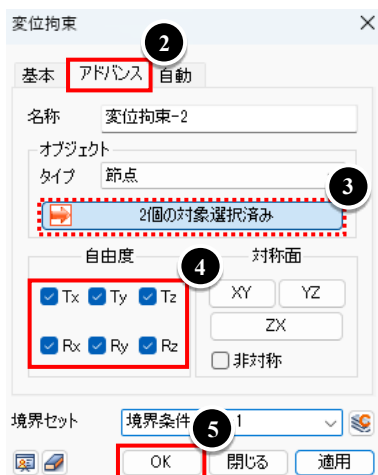
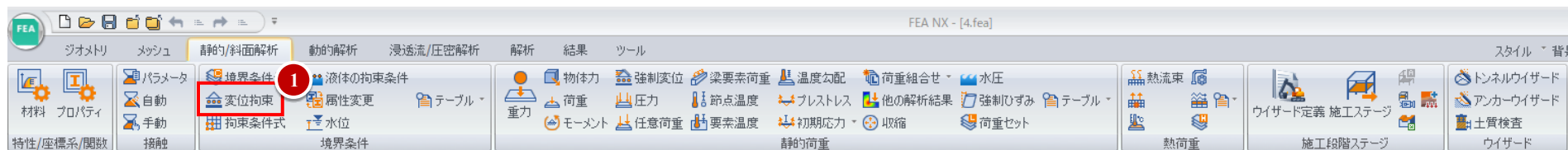

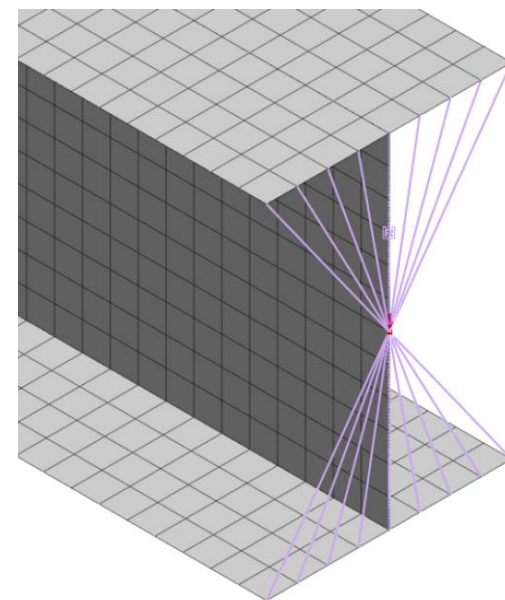
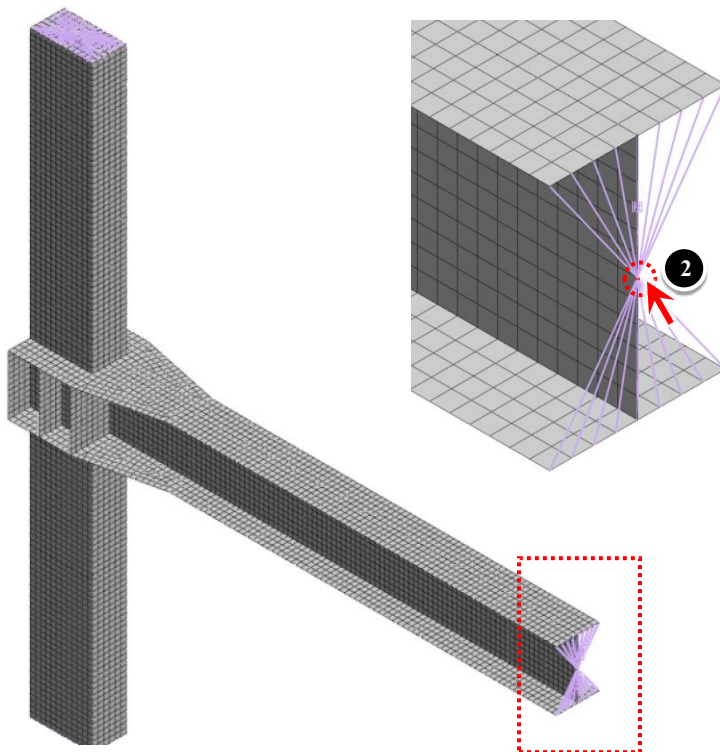
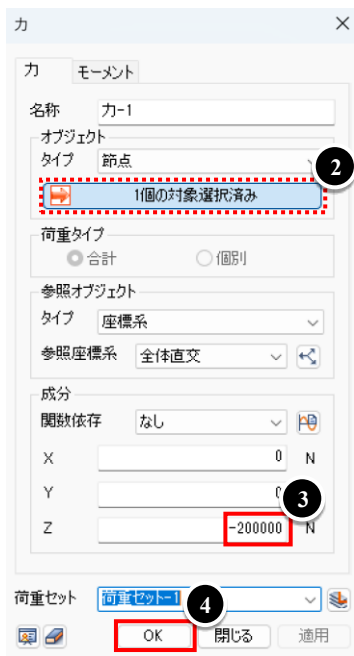
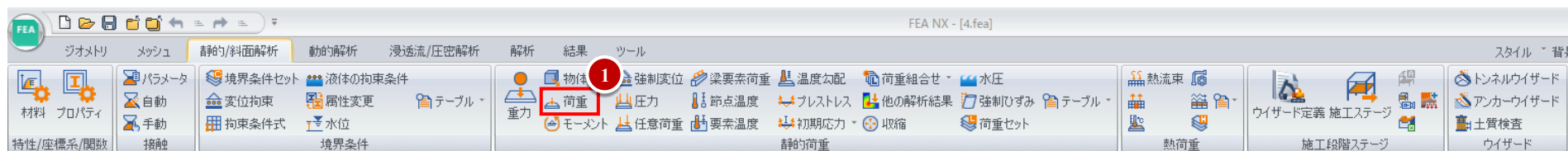

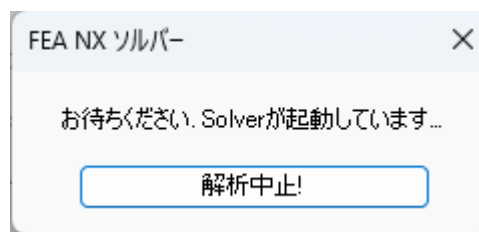
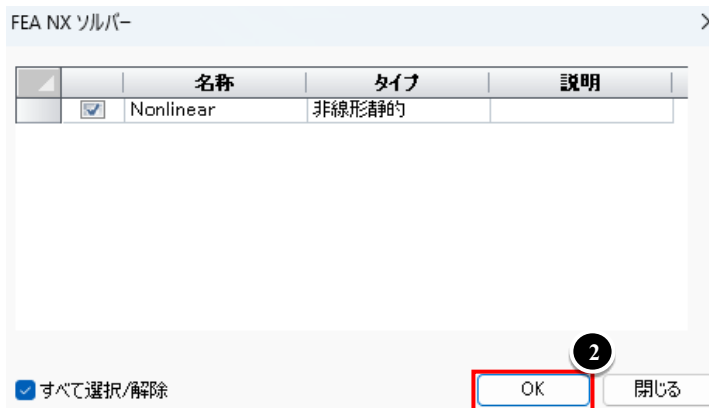
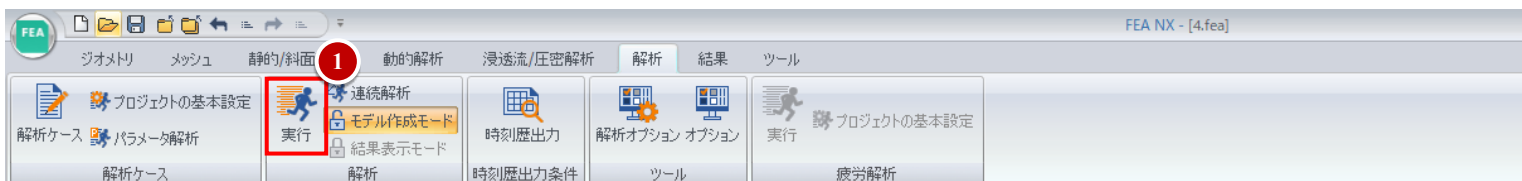

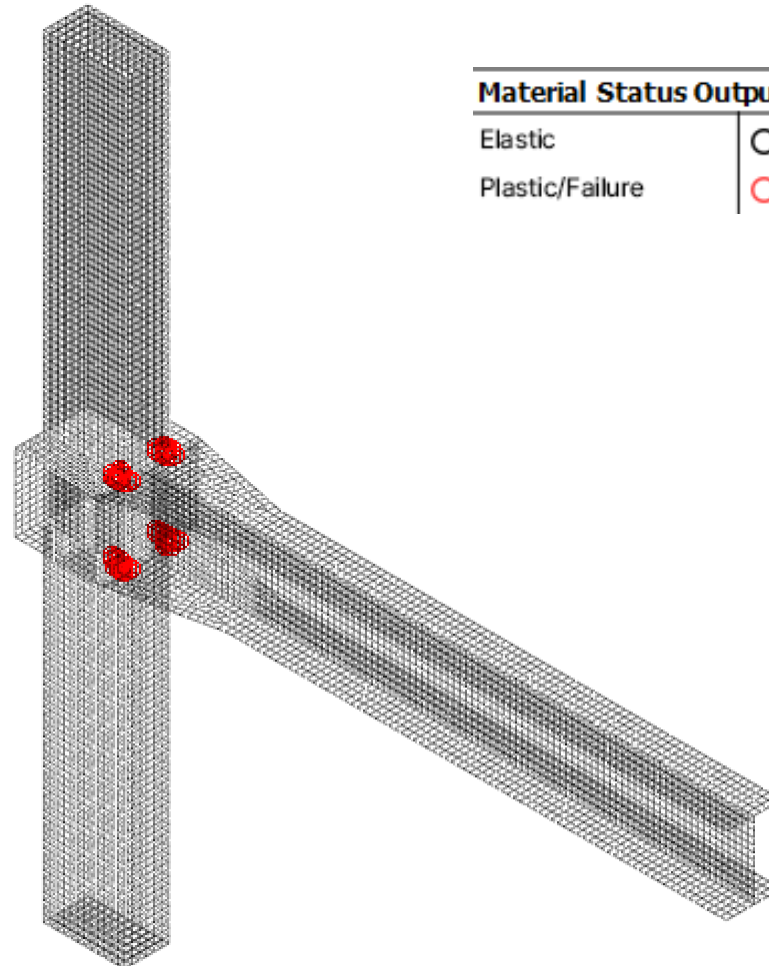
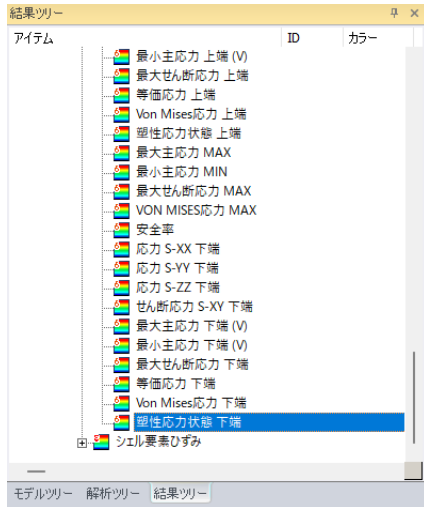

Material Status Output

Elastic



Plastic/Failure



○弾性

○塑性

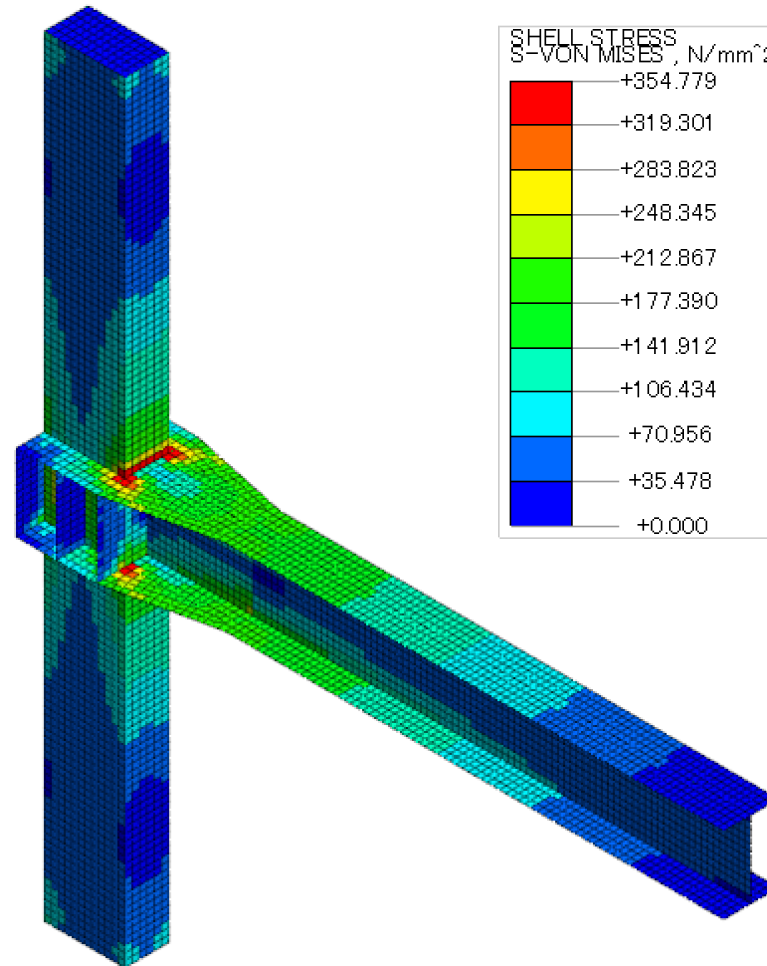
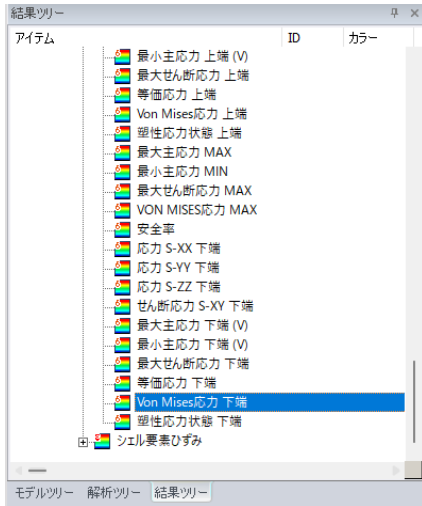

動画化

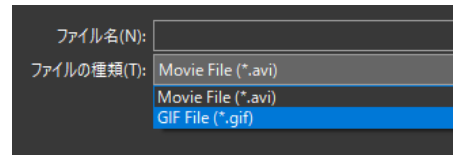
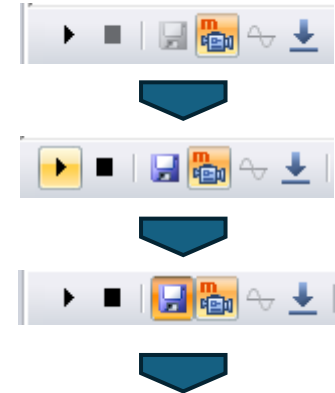

FEA NXで学ぶ 初心者向けFEM解析体験セミナー
マイダスアイティジャパン 建設技術部

ご清聴
ありがとうございました。

